

ALINCO

VHF FM HANDHELD TRANSCEIVER

DJ-190

INSTRUCTION MANUAL

ALINCO, INC.

Head office: "TWIN 21" MID Tower Building 25F
1-61, 2-Chome, Shiromi, Chuo-ku, Osaka 540-8580 Japan
Phone: 06-946-8150 Fax: 06-946-8175 Telex: 63086
E-mail: 101243.1446@compuserve.com
U.S.A.: 438 Arapola Ave., Suite 130, Torrance, CA 90501-6201 U.S.A.
Phone: 310-618-8616 Fax: 310-618-8758
<http://www.alinco.com/>
Germany: Eschborner Landstrasse 55, 60489 Frankfurt am Main, Germany
Phone: 069-786018 Fax: 069-789-60766

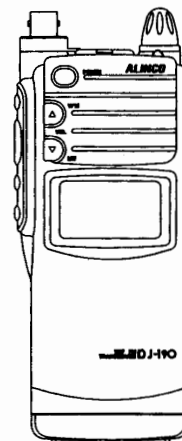

Thank you for purchasing this **ALINCO** transceiver.
To obtain optimum performance from this transceiver, read this Instruction Manual thoroughly, and keep it for future reference.
The LCD display examples in this Instruction Manual use the DJ-190T's LCD display.

©Copyright 1998 Alinco, Inc. Osaka Japan
Printed in Japan

PS0227B

N O T I C E

This equipment has been tested and found to comply with the limits pursuant to Part 15 of the FCC Rules. These limits are designed to provide reasonable protection against harmful interference in a residential installation. This equipment generates, uses, and can radiate radio frequency energy, and if not installed and used in accordance with the instructions, may cause harmful interference to radio communications. However, there is no guarantee that interference will not occur in a particular installation. If this equipment does cause harmful interference to radio or television reception, which can be determined by turning the equipment off and on, the user is encouraged to try to correct the interference by one or more of the following measures.

- *Reorient or relocate the receiving antenna.*
- *Increase the separation between the equipment and receiver.*
- *Connect the equipment into an outlet on a circuit different from that which the receiver is connected.*
- *Consult the dealer or an experienced radio/TV technician for help.*

Table of Contents

<p>1. INTRODUCTION 1</p> <p>2. INNOVATIVE AND NEW FEATURES 1</p> <p>3. ACCESSORIES 1</p> <p> 3-1 Standard Accessories 1</p> <p> 3-2 Optional Accessories 2</p> <p>4. INSTALLATION 2</p> <p> 4-1 Mobile Installation 3</p> <p> 4-2 Base Station Installation 3</p> <p> 4-3 Charging Your Battery 3</p> <p>5. SPECIFICATIONS 4</p> <p> 5-1 General 4</p> <p> 5-2 Transmitter 5</p> <p> 5-3 Receiver 5</p> <p>6. QUICK REFERENCE 6</p> <p> 6-1 Receive 6</p> <p> 6-2 Transmit 7</p> <p> 6-3 Programming 8</p> <p> 6-4 Scanning 10</p> <p> 6-5 Tone Burst 10</p> <p>7. CONTROLS and FUNCTIONS 11</p> <p> 7-1 Top, Front, Sides and Rear View 11</p> <p> 7-2 LCD Display 14</p>	<p>8. GETTING STARTED 16</p> <p> 8-1 Receiving 16</p> <p> Step Key 16</p> <p> Changing Frequency in One MHz Steps 16</p> <p> 8-2 Transmitting 16</p> <p> 8-3 Transceiver Modes 17</p> <p> VFO (Variable Frequency Oscillator) Mode 17</p> <p> Memory Mode 17</p> <p> Programming a Memory Channel 17</p> <p> Scroll Memory 18</p> <p> 8-4 Other Functions 18</p> <p> Battery Save Function (BS) 18</p> <p> Beep ON/OFF 18</p> <p> KL (Key Lock) 18</p> <p> FL (Frequency Lock) 19</p> <p> APO (Automatic Power Off) 19</p> <p> CTCSS Tone Frequencies 19</p> <p> T.O.T. (Time-Out-Timer) 20</p> <p> T.O.T. Penalty Time 20</p> <p> Busy Channel Lock Out 20</p> <p> Cable Cloning 20</p> <p> 8-5 Resetting 22</p> <p> 8-6 CTCSS Decoder Unit EJ-28U Installation 22</p> <p>REFERENCE 23</p>
--	---

1. INTRODUCTION

We at Alinco would like to thank you for purchasing the ALINCO DJ-190. Radios and other products made by ALINCO rank as some of the finest in the world. Your DJ-190 has been manufactured and tested very carefully at the factory and will give you satisfactory operation for many years.

We are confident that you will be very satisfied with your choice of this fine ALINCO radio.

2. INNOVATIVE AND NEW FEATURES

The DJ-190 features some of the most advanced features and reliable engineering available anywhere. Our design policy at ALINCO is focused on developing innovative usable features, including the following:

- Easy to readout LCD.
- Comes equipped with a 50 CTCSS Tone encoder, and with the optional EJ-28U Tone Squelch Decoder unit, the CTCSS Tones can be decoded for selective receiving.
- Tone Burst (1750Hz) feature comes built into the DJ-190.
- T.O.T. (Time Out Timer) can be set to a Duty Cycle most accommodating to the user's requirements.
- Cable Cloning function.
- TX LED and RX LED
- Menu mode ("set-mode") lets you program many features by simple steps:
 - (1) Holding down the **F** key, press the **MONI** key to enter the set-mode;
 - (2) Choose item by **Δ** / **▷** keys. (LCD shows the item no., title, and current setting);
 - (3) Rotate the dial to change the setting. Go to step (2) for further item(s), or press the PTT key to exit.

3. ACCESSORIES

3-1 Standard Accessories

When you unpack your ALINCO transceiver, you will find these standard accessories:

- **EBP-37N** (4.8V DC 700mAH) Ni-Cd battery*
- **EDC-63** (120V AC) Wall charger (DJ-190T)*
- **EDC-64** (220V AC) Wall charger (DJ-190E)*
- Flexible rubber duckie antenna
- Belt clip with two screws
- Hand strap
- Instruction Manual

*May differ depending on the version you bought.

3-2 Optional Accessories

- EJ-28U** CTCSS Decoder Unit
- EBP-33N** (4.8V DC 650mAH) Ni-Cd battery
- EBP-34N** (4.8V DC 1200mAH) Ni-Cd battery
- EBP-35N** (7.2V DC 900mAH) Ni-Cd battery
- EBP-36N** (9.6V DC 650mAH) Ni-Cd battery
- EBP-37N** (4.8V DC 700mAH) Ni-Cd battery (standard)
- EDH-16** Dry-cell battery case (AA x 4)
- EDC-36** Mobile Cigarette lighter adapter with active noise filter
- EDC-37** External DC supply cable
- EDC-60** (120V AC) Rapid charger
- EDC-61** (220V AC) Rapid charger
- EDC-63** (120V AC) Wall charger
- EDC-64** (220V AC) Wall charger
- EMS-9** Speaker microphone
- EME-12** Headset with VOX
- EME-13** Earphone and mic with VOX
- EME-6** Earphone
- ESC-28** Softcase (for use with EBP-33N)
- ESC-29** Softcase (for use with EBP-37N)
- ESC-30** Softcase (for use with EBP-34N/35N/36N)
- EBC-6** Mobile bracket

4. INSTALLATION

External Antenna Installation:

When an external antenna is used, 50 ohms coaxial cable is required for all antenna installations.

Please refer to the antenna manufacturer's manual for the proper installation and mounting information. After installing your antenna, ensure that you have the proper matching and best possible SWR reading. High SWR or improper matching can cause severe damage to your unit and may void the warranty.

(Note: When your DJ-190 is used with an external antenna, you may experience some intermodulation problem from other communication services. This is caused due to the high sensitivity of the DJ-190's receiver front-end circuit and its design for wideband operation. If it is the case, we recommend you to use an antenna that has a lower gain or the rubber duckie antenna comes standard with the radio.)

Caution: High RF environments can cause severe damage to your unit. Ensure that you are not in a High RF environment when operating your DJ-190.

4-1 Mobile Installation

1. Location

The transceiver may be installed in any position* in your car, where the controls are easily accessible while maintaining safe operation of your vehicle.

Optional EBC-6 mobile bracket is recommended.

(*local regulations may apply)

2. Power Requirements

The transceiver can be operated from any regulated 12 or 13.8V DC negative ground source.

For mobile use, use always with the optional EDC-36 cigarette lighter adapter with active noise filter.

4-2 Base Station Installation

For a fixed base operation, 4.8V DC ~ 13.8V DC Regulated Power Supply providing a minimum of 2A continuous is required.

When using the optional EDC-37 DC cable, connect the red lead of to the Positive (+) terminal, and the black lead to the Negative (-) terminal of the DC Power Supply.

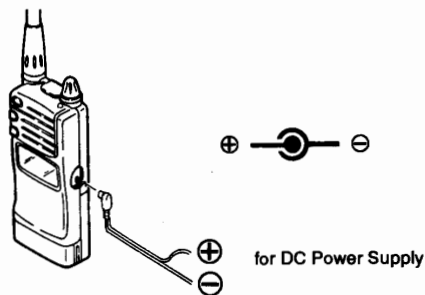

4-3 Charging Your Battery

Before operating your DJ-190, you must charge your Ni-Cd battery with the wall charger that comes standard with your radio.

It will take approx. 12 to 14 hours to be fully charged.

5. SPECIFICATIONS

The specifications outlined for this product are for use in the amateur band only. No guarantee or warranty, either specific or implied, will apply to any function or specification outside the amateur band. Individual radios may experience different performance and/or specification levels.

Any modification for the purpose of operation outside of the amateur band will result in voiding any warranties associated with this transceiver and may be a violation of FCC regulations.

All specifications and features are subject to change without notice or obligation.

5-1 General

Frequency Coverage	RX	TX
DJ-190T (U.S. Amateur Version)	136.000 ~ 173.995MHz	144.000 ~ 147.995MHz
DJ-190E (European Amateur Version)	144.000 ~ 145.995MHz	144.000 ~ 145.995MHz
DJ-190TA1 (Commercial Version)	136.000 ~ 173.995MHz	136.000 ~ 155.000MHz
DJ-190TA2 (Commercial Version)	136.000 ~ 173.995MHz	150.000 ~ 173.995MHz
Channel Spacing:	5, 10, 12.5, 15, 20, 25, 30kHz steps	
Memory Channels:	40 Channels	
Antenna Impedance:	50 Ohms unbalanced	
Frequency Stability:	± 5 ppm	
Microphone Input Impedance:	2K Ohms nominal.	
Signal Type:	F3E (FM)	
Power Supply Requirements:	4.8 ~ 13.8V DC (4.8V DC standard)	
Current Consumption	Transmitting: Approx. 1.5 Amp. in High Power Setting	
	Receiving: Squelched Approx. 50mA	
Operating Temperature:	- 10 to + 60 degrees (Celsius), 14 to 140 degrees (Fahrenheit)	
Ground:	Negative	
Dimensions:	57(W) × 151(H) × 27(D) mm without projections, with EBP-37N	
Weight:	Approx. 300g (with EBP-37N)	
Subaudible Tones (CTCSS):	Encoder installed (50 tones)	

6-2 Transmit

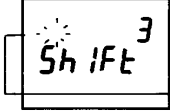
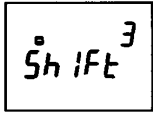
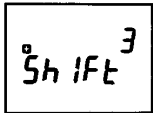

SIMPLEX

Press and hold the **F** key, and press the **MONI** key. Press either the **▲** key or the **▼** key to display the "Sh iFt" (Shift) icon on the LCD. Rotate the main tuning dial **NOT TO** show the **+** or the **-** icon on the LCD.

+ and **-** disappear

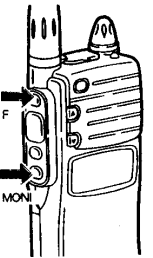

OFFSET

Press and hold the **F** key, and press the **MONI** key. Press either the **▲** key or the **▼** key to display the "Sh iFt" icon on the LCD. Rotate the main tuning dial so that the display shows either the **+** or the **-** icon on the left side above the frequency segment of the LCD. Simplex operation is indicated as absence of either the **+** or **-** icon. Press either the **▲** key or the

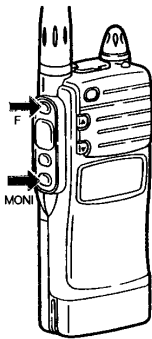
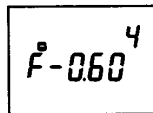
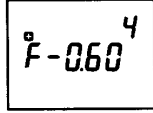

tone ENCODE (and DECODE)

Press and hold the **F** key, and press the **MONI** key. Press either the **▲** key or the **▼** key to display the "t ****" (the value of **** being the tone frequency) icon on the LCD. Rotate the main tuning dial for the desired tone. Press and hold the **F** key, and press

the **▼** key to display the "F-***" (the value of *** being offset frequency in MHz) icon on the LCD. Rotate the Main Tuning Dial to change offset frequency. **+** means transmit will take place on the frequency shifted upwards by the shown offset than the receiving frequency; **-** means downwards in the same sense. (Press PTT on the side once to exit.)

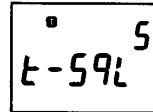
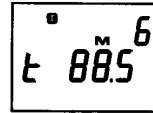

the **MONI** key. Press either the **▲** key or the **▼** key to display the "t-59L" (tone squelch) icon on the LCD. Rotate the main tuning dial to display the **T** icon on the top left of the LCD. To activate Tone Squelch (decoder) rotate further to display **T SQL**. (Note: For Tone Squelch, optional CTCSS decoder EJ-28U must be installed prior to the programming.)

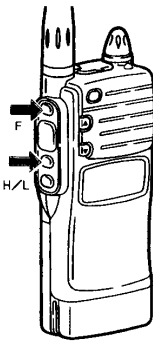

POWER SETTING

Press and hold the **F** key, and press the **LAMP** key to select the desired output power setting. When the "L" (Low) icon is NOT displayed on the bottom left of the LCD, the radio is set on the high power setting.

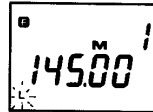

6-3 Programming

MEMORY MODE



Press and hold the **F** key, and press the **▲** key to display the "M" icon above the frequency segment of the LCD. The same procedure bring back the VFO mode (the "M" icon disappears).

MEMORY SCROLL

Enter the MEMORY MODE, and rotate the Main Tuning Dial.

MEMORY WRITE

1. Enter the MEMORY MODE.
2. Rotate the Main Tuning Dial to select the desired memory channel to program.
3. Enter the VFO MODE. Set the frequency, tone, shift, etc. accordingly.
4. Press and hold the **F** key, and press the **▼** key to store the information into the memory channel. (Stored information: Frequency, Offset, Shift direction, CTCSS setting, CTCSS frequency, Power H/L, Skip, Battery Save setting.)
5. A high tone beep will sound indicating that the programming is completed successfully.
6. Memorized items in a channel may be temporarily changed while you stay on that channel, but the written information remains as originally programmed. The original items will be called if you change channel elsewhere

(or to VFO) then come back to the memory channel, unless re-programmed with **F** and **D_{sw}** keys.

MEMORY ERASE

1. Enter the MEMORY MODE.
2. Rotate the Main Tuning Dial to select the memory channel to erase.
3. Press and hold the **F** key, and press the **D_{sw}** key to erase the program information on the memory channel.
4. A high tone beep will sound and the flashing "M" icon will appear on the LCD indicating that the memory content has been erased.

MEMORY SKIP (SCAN SKIP)

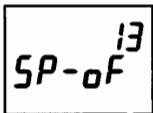

1. Enter the MEMORY MODE. Rotate the Main Tuning Dial to the channel you desire to skip while scanning.
2. Press and hold the **F** key, and press the **MONI** key.
3. Press either the **D_{sw}** key or the **D_{sw}** key to display the "5P- ***" (***: on or off) on the LCD.
4. Rotate the main tuning dial to display the "5P-0n" icon on the LCD.
5. The frequency decimal point will disappear indicating that the memory channel will be skipped during the scanning.
6. To cancel the MEMORY SKIP, repeat these steps.

MEMORY CHANNEL DISPLAY MODE

Instead of displaying a frequency, in memory mode, the corresponding memory channel number only may be displayed. In this mode you cannot enter VFO and you cannot program or re-program a memory channel unless you first exit the Memory Channel Display Mode. To enter this mode, first program FL or KL (see Section 8-4 Other Functions), and following keys should be pressed in sequence.

"F" key: once
 ↓
 "▲" key: 6 times
 ↓
 "▼" key: 3 times
 ↓
 "MONI" key: once

The display turns to Channel Number. (At least one channel has to be already programmed when you do this, or else "ch-Err" will appear.) Then cancel the FL or KL. Where "skip" channels have been set, the hyphen between "ch" and the channel number is not displayed. Repeat the same steps to exit this mode and get back the frequency display.

6-4 Scanning

DJ-190 has the timer scan function. In this operation, scan stops at a busy channel and resumes after 5 seconds.

VFO (BAND) SCAN

Enter the VFO MODE. Press the **LAMP** key for longer than three seconds, and the frequency decimal point will start blinking to indicate the scanning mode.

MEMORY SCAN

Enter the MEMORY MODE, and press the **LAMP** key for longer than three seconds.

SCAN DIRECTION

In the SCAN MODE, rotate the Main Tuning Dial counter-clockwise to scan downward and clockwise to scan upward.

STOP SCAN

Press the **LAMP** key for longer than three seconds again, or press the **PTT** key.

Note: For those memories programmed with SKIP they will be passed without receiving while scanning.

SCAN SKIP

See page 9 "MEMORY SKIP". Decimal point disappears from the frequency display, and the channel will be skipped when scanning.

6-5 Tone Burst

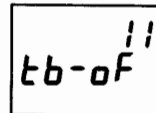

Your DJ-190T has the Tone Burst Function. To use the Tone Burst Function, perform following steps:

1. Press and hold the **F** key, and press the **MONI** key.
2. Press either the **▲** key or the **▼** key to display the "tb- ***" (***: on or off) on the LCD.
3. Rotate the main tuning dial to display the "tb-0n" icon on the LCD.
4. To transmit the 1750Hz of the burst tone, press and hold the **PTT** switch, and press the **MONI** key.
5. Repeating these steps each time will toggle between the "tb-0n" (Tone burst on) setting or "tb-0F" (Tone burst off) setting.

Note: The Tone Burst Function is activated for DJ-190E as factory default.

7. CONTROLS/FUNCTIONS

7-1 Top, Front, Sides and Rear View

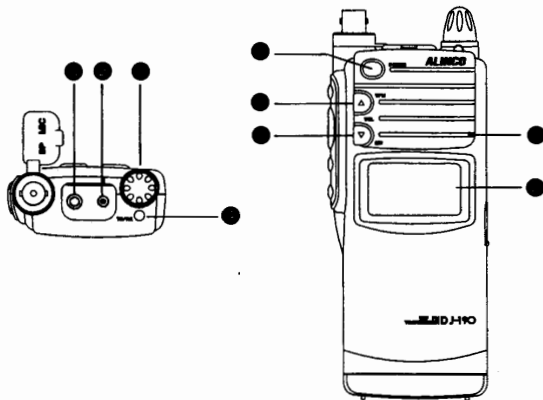

● **MAIN TUNING DIAL**

The main tuning dial/knob may be rotated in either direction to select transmit/receive frequencies, memory channels, transmit frequency offsets, and sub-audible tones.

● **EXTERNAL MICROPHONE JACK**

When an external microphone is preferred, plug in a 2.5mm stereo plug into this jack.

The impedance of the external microphone input is 2k ohms, therefore, most of electret condenser microphone can be used. A dynamic microphone should not be used.

● **EXTERNAL SPEAKER JACK**

When an external speaker is preferred, plug in a 3.5mm mono plug into this jack.

The impedance of the external speaker should be 8 ohms. When an external speaker is used, the internal speaker will be disabled.

● **TX/RX LED**

When the PTT switch is pressed, this LED would be lit with red color indicating that the radio is in the transmit mode. When the squelch is opened or incoming signals are received, this LED would be lit with green color.

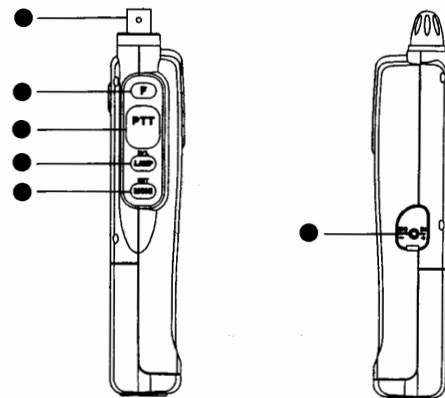

● **LCD DISPLAY PANEL**

Highly visible under all lighting conditions, the LCD panel displays functional information during transceiver operations. Refer to LCD DISPLAY section of this manual.

● **BNC ANTENNA CONNECTOR**

Connect the supplied rubber duckie antenna. When an external antenna is connected, please make sure that your antenna has a low SWR (Standing Wave Ratio).

● **F (FUNCTION) KEY**

Before using your DJ-190, it is recommended that you thoroughly familiarize yourself with the operation of this key, as it is essential for the majority of the radio's functions.

The **F** key allows you to access the secondary functions.

You may also reset the radio by holding the **F** key as you turn on the unit. This restores the DJ-190 to the default settings and erases all memory channels besides other settings.

● **PTT (PUSH TO TALK) SWITCH**

To transmit, press and hold this switch. When you release it, the unit will return to the receive mode.

● **LAMP (H/L) KEY**

When this key is pressed, the LCD will be illuminated. It will automatically turn off after five seconds. To keep illuminating the LCD, press and hold this key and turn the power on; in this case, each push of the LAMP key will toggle the illumination without the timed light off.

This key is also used to change the output power setting.

To change the output power setting, press and hold the **F** key, and press this key.

When the "L" icon appears on the bottom left of the LCD, the radio is set to the low power output mode. When the "L" icon is NOT displayed on the LCD, the radio is set to the high power output mode.

● **MONI (MONITOR)/BS KEY**

This key is used to unmute squelch, and a weak or intermittent signal can be monitored regardless the squelch setting. This is also available to monitor receive frequencies when TSQ (Tone Squelch) is set.

Press and hold this key and turn on the power to toggle BS (Battery Save) on/off.

To turn power on the unit, press and hold for about one second.

To turn power off, press again.

● **POWER SWITCH**

● **UPWARD KEY**

This key is used to increase the speaker output volume. While pressing and holding this key, the "VOL" icon will appear on the top middle of the LCD indicating that the volume level is setting.

This key is also used to toggle between the VFO mode and the Memory mode. To change the mode, press and hold the **F** key, and press this key. When the radio is in the Memory mode, the "M" icon will appear on the LCD with the memory channel number.

● **DOWNWARD KEY**

This key is used to decrease the speaker output volume. While pressing and holding this key, the "VOL" icon will appear on the top middle of the LCD indicating that the volume level is setting.

This key is also used to store (write) the VFO fre-

quency into the memory channel.

To store into the memory channel, press and hold the **F** key, and press this key.

Speak into the microphone from approximately 10cm or 3" distance.

Plug in the optional EDC-36 cigarette lighter adapter with active noise filter for mobile operation. The jack is polarized, the center pin is positive and outer pin is negative.

Applying excessive or reverse voltage will cause severe damages and will void the radio's warranty.

● **MIC**

● **DC JACK**

7-2 LCD Display

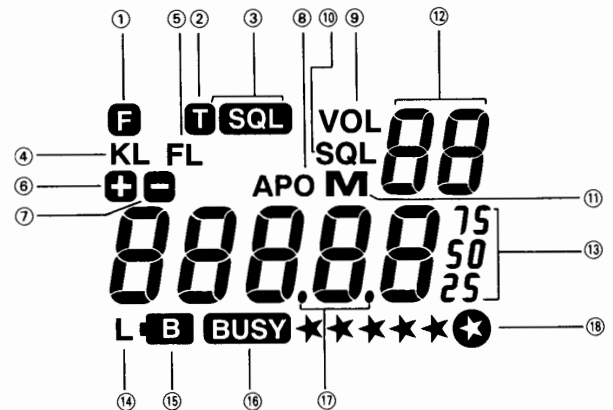

① **F**

When the **F** icon appears, secondary function keys may be activated.

② **T**

It appears when the tone encoder is activated. (page 7)

③ **T SQL**

It appears when the tone squelch is activated. (pages 7-8)

④ **KL**

The "KL" icon appears when the Key Lock is activated. (page 18)

⑤ **FL**

The "FL" icon appears when the Frequency Lock is activated. (page 19)

- ⑥ **+** It indicates the plus offset direction. That is, your transmit frequency will be higher than the receiving frequency by the offset-frequency amount. (page 7)
- ⑦ **-** It indicates the minus offset direction. That is, your transmit frequency will be lower than the receiving frequency by the offset-frequency amount. (page 7)
- ⑧ **APO** It appears when the APO (Automatic Power Off) function is activated. (page 19)
- ⑨ **VOL** It appears while the volume level is being adjusted by either the upward key or downward key. (page 6)
- ⑩ **SQL** It appears while the squelch level is being adjusted. (page 6)
- ⑪ **M** In the Memory Mode, the "M" icon appears. (pages 8-9)
In the VFO Mode, the "M" icon is not displayed.
- ⑫ **BB** While either the volume level or squelch level is adjusted, numbers appear indicating the setting level (min. 0 ~ max. 31).
In the Memory Mode, it indicates the selected memory channel number (0 ~ 39). When in the set-mode, it indicates the item number.
- ⑬ **88888** It indicates the transmit/receive frequency, offset frequency, tone frequency, tuning step.
- ⑭ **L** When the low power output is selected, the "L" icon appears.
When the "L" icon is not displayed, the high power output is selected. (page 8)
- ⑮ **B** When the voltage of the battery is dropped and need to be recharged, the "B" icon appears.
If it is displayed, turn off the power and recharge the battery. It will take approximately 12 to 14 hours to be fully charged with EDC-63 or EDC-64.
- ⑯ **BUSY** The **BUSY** icon will appear when a signal is received, or squelch is unmuted. (page 6)
(During TSQL, the audio remains muted unless the tones match, regardless of the "BUSY" icon.)
- ⑰ **(. decimal point)** It indicates: MHz for transmit/receive and offset frequencies.
kHz for channel step.
Hz for encoded sub-audible tone (CTCSS) tone frequency.
- ⑱ **★★★★★** In the Scan Mode, the decimal point flashes.
It indicates the received signal strength and/or the output power level.

8. GETTING STARTED

8-1 Receiving

1. Set the following controls of the radio.
POWER SWITCH: OFF
VOLUME CONTROL: Set to "0" level
SQUELCH CONTROL: Set to "0" level
2. Install a battery pack or connect external 4.8 ~ 13.8 Volt DC Regulated Power Supply to the radio.
3. Ensure an antenna with the appropriate antenna connector is connected.
4. Turn the POWER switch on.
5. Press the upward key until a signal (or noise) is heard through the speaker.
6. The LCD display will indicate frequency.
7. Rotate the Main Tuning Dial, to select a frequency. Adjust the squelch level setting until the noise disappears from the speaker.

STEP KEY

The STEP function is used to select the desired incremental changes of receive/transmit frequencies, in step of 5, 10, 12.5, 15, 20, 25, 30kHz. Use this feature as follows:

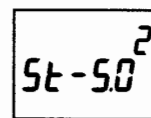

1. Press and hold the **F** key, then press the **MONI** key.
2. Press either the **▲** key or the **▼** key to display the "St ***" (***) : step value in kHz) icon on the LCD.
3. Change the channel step by using the main tuning dial.
4. Press the **PTT** switch to return to the operating frequency.
5. After the channel step is set, the receive/transmit frequency will increase or decrease by the value selected when you turn the main tuning dial.

CHANGING FREQUENCY IN ONE MHz STEPS

In the VFO Mode, pressing and holding the **F** key, rotate the Main Tuning Dial. This will change the frequency Up or Down in one MHz Steps.

8-2 Transmitting

Cautions: Ensure that you always use the original rubber duckie antenna or an external antenna with low SWR (Standing Wave Ratio) readings. Improper antenna connection may cause damage to the radio and may void warranty.

1. Make sure that you follow all steps set forth in the "6. GETTING STARTED" section first.

2. Select a frequency, shift direction, shift value and CTCSS Tone (Sub-Audible Tone) frequency.
3. Check to see that the frequency is not in use before transmitting.
4. Select appropriate transmitter output level.
5. Press and hold the PTT switch and speak approximately 10cm or 3" from the microphone located just above the LCD display.



8-3 Transceiver Modes

Your DJ-190 has 2 modes; VFO mode, and MEMORY mode.

VFO (Variable Frequency Oscillator) MODE





The transceiver will be in the VFO mode. This mode is used to change frequency and select the desired channel step, offset frequency, shift direction, tone frequency, tone setting, Power H/L, Busy-Channel-Lock-Out, and BS (battery save ON/OFF).

MEMORY MODE

The following guidelines will help you to program and manipulate memory channels. In the Memory mode, memory channels can be reviewed. To select the Memory mode, press and hold the  key, and press the  key.

PROGRAMMING A MEMORY CHANNEL

To write VFO informations into a memory channel, perform the followings.

1. Enter the MEMORY MODE.
2. Rotate the Main Tuning Dial to choose the desired memory channel number (clockwise to increase, counter-clockwise to decrease). Select the desired memory channel number (0 to 39).
3. If the Memory Channel Number is flashing, it indicates the memory channel is vacant. A non-vacant channel can be over-written with new data.
4. Enter the VFO mode.
5. Select the receive frequency.
6. Select the shift  or , or none.
7. Select the required offset (Consult your Repeater Directory) if shift is required.
8. Select the proper CTCSS Tone (Sub-Audible Tone) if needed.
9. Select the Tone Squelch if needed (an optional Tone unit (EJ-28U) is required).
10. Other data, such as Power H/L, and BS (battery save OFF/ON) may be set, if so desired to memorize into the channel.
11. Press and hold the  key, and press the  key to write (store) the information to the memory.

SCROLL MEMORY

Scrolling memory channels up or down can be accomplished as followings;

1. Select the MEMORY MODE. The memory channel number (0-39) will appear.
2. Turn the Main Tuning Dial to increase or decrease the memory channel.

8-4 Other Functions

BATTERY SAVE FUNCTION (BS)

The battery save function helps conserve battery power. When no operation is performed and no signal is received for 5 seconds, the battery save function will activate automatically.

The factory's default setting of the battery save function is ON.



To deactivate this function, press and hold the **MONI** key while pressing and holding the power switch. The "  " icon will be displayed on the LCD indicating that the battery save function is disabled.

Repeating above steps will re-activate the battery save function.

(Note: Regardless of the above, the battery save function is temporarily disabled during the Scanning mode.)

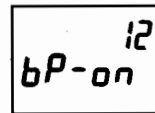
BEEP ON/OFF

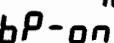

Press and hold the  key, and press the **MONI** key. Press either the  key or the  key to display the "  " (**: on or off) on the LCD. Rotate the main tuning dial to switch to on or off. This will toggle between beep sound on or off.

KL (KEY LOCK)





This function prohibits access to some functions to prevent accidental change.

Following controls are prohibited during the activation of the KL function.

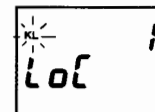
- V/M (VFO ↔ Memory)
- H/L (Power High/Low)
- MW (Memory Write)
- Scan

To activate this function, perform the followings;



1. Press and hold the  key, and press the **MONI** key.
2. Press either the  key or the  key to display the "  " icon on the LCD.
3. Rotate the main tuning dial to display the "KL" icon on the LCD.
4. To deactivate this function, rotate the main tuning dial not to display either the "KL" or the "FL" icon on the LCD.

FL (FREQUENCY LOCK)

This function disables the channel or frequency change by the dial, in addition to those prohibited in the KL function.

To activate this function, perform the followings;

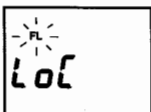

1. Press and hold the **F** key, and press the **MONI** key.
2. Press either the **Δ** key or the **▽** key to display the "LO" icon on the LCD.
3. Rotate the main tuning dial to display the "FL" icon on the LCD.
4. To deactivate this function, rotate the main tuning dial not to display either the "KL" or the "FL" icon on the LCD.

APO (AUTOMATIC POWER OFF)

The APO function automatically turns the transceiver power off if no switches or controls are operated, or no signal is received after 30 minutes. This function protects against battery drainage when you forget to turn the power off.

To activate the APO function, perform the followings:



1. Press and hold the **F** key, and press the **MONI** key.
2. Press either the **Δ** key or the **▽** key to display the "AP" icon on the LCD.
3. Rotate the main tuning dial to display the small "APO" icon on the LCD.
4. While the "APO" icon appears, if no operation are performed for 30 minutes, Morse code "OFF" sound will be heard and the power will be shut down.

CTCSS TONE FREQUENCIES

There are 50 different tone frequencies available for tone encode. Decoder EJ-28U is available as an option.

Following is the list of those frequencies:

(Hz)

67.0	69.3	71.9	74.4	77.0	79.7	82.5	85.4	88.5	91.5
94.8	97.4	100.0	103.5	107.2	110.9	114.8	118.8	123.0	127.3
131.8	136.5	141.3	146.2	151.4	156.7	159.8	162.2	165.5	167.9
171.3	173.8	177.3	179.9	183.5	186.2	189.9	192.8	196.6	199.5
203.5	206.5	210.7	218.1	225.7	229.1	233.6	241.8	250.3	254.1

T.O.T. (Time-Out-Timer)

A time-out-timer automatically shuts down transmission and resumes receiving after a set period of continuous transmit time.

To protect the radio from excessive transmit, a Time Out Timer has been installed. This can be programmed to activate from 30 seconds to 450 seconds (7.5 Minutes) in 30 seconds step.

Press and hold the **F** key, and press the **MONI** key.

Press either the **Δ** key or the **▽** key to display the "t-***" (***: timer limit in second) icon on the LCD.

The LCD will display the selected Time Out Time in seconds. Use the Main Tuning Dial to change the Time Out setting. Push the PTT to exit.

T.O.T. PENALTY TIME (Works only if the T.O.T. function above is activated)

After DJ-190 times out by exceeding the set T.O.T. maximum time, a penalty time disallowing re-transmission can be programmed.

Press and hold the **F** key, and press the **MONI** key.

Press either the **Δ** key or the **▽** key to display the "t-***" (***: penalty time in second) icon on the LCD.

The LCD will display the selected Penalty Time in seconds (1 ~ 15 sec.)

Use the main tuning dial to change the Penalty Time setting.

Push the PTT to exit.

BUSY CHANNEL LOCK OUT

This function limits transmission by allowing transmitting in the following conditions only:

- when a signal is not received (i.e. the "BUSY" icon is not displayed); or
- in case **TSQL** is set, when a signal with matching tone is received.

Press and hold the **F** key, and press the **MONI** key.

Press either the **Δ** key or the **▽** key to display the "LO-F" icon on the LCD.

Rotate the main tuning dial so that LCD display show either the "LO-F" or the "LO-n" icon on the LCD.

Push the PTT to exit.

CABLE CLONING

With an interface cable (see following diagram), cloning is possible with your Alinco DJ-190. This means that the entire memory and VFO contents of one DJ-190 will be transferred to another DJ-190 via the interface cable.

Here is how it works:

1. Turn power off on both radios.
2. Plug-in one end of the interface cable into the speaker jack of one radio, and plug-in the other end into the speaker jack of the other radio.
3. Turn on the power on both radios.
4. Press and hold the **MONI** key, then press the **PTT** switch **three times** on both radios.
The "**CLonE**" icon will appear on the LCD of both radios.
5. Press the **MONI** key of the radio receiving the information to be copied (SLAVE RADIO).
The "**rEAdY**" icon will appear on the LCD.
6. Press the **PTT** switch of the radio (MASTER RADIO) whose memory will be transferred to the slave radio.
The "**PUSH**" icon will appear on the LCD. Press the **PTT** switch again on the master radio to start transfer of information data.
7. During the cloning, the "**SEnd**" icon will appear on the LCD of the master radio, and the "**GEt**" icon will appear on the LCD of slave radio. After the cloning, the "**End**" icon will appear for two seconds on the LCD of slave radio.
8. Turn the power off on both radios.
9. Disconnect the interface cable.
Clone interface cable should be built as follows:

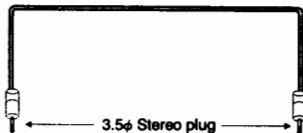

MASTER

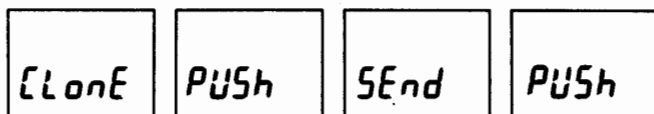

SLAVE

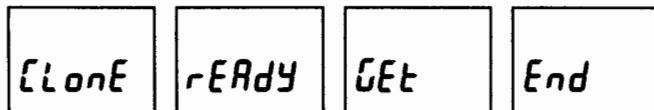

8-5 Resetting

While pressing the **F** key, turn on power.

	DJ-190T	DJ-190E
VFO Frequency	145.000MHz	145.000MHz
Channel Step	5kHz	12.5kHz
Shift	None	None
Offset Frequency	0.6MHz	0.6MHz
Tone Setting	None	None
Tone Frequency	88.5Hz	88.5Hz
Transmitter Output	Low	Low
Key Lock	Off	Off
Time Out Timer	Off	Off
Tone Burst	Off	On
Battery Save function	On	On
Beep	On	On
APO	Off	Off
TOT Penalty Time	5	5
Busy Channel Lock Out	Off	Off

8-6 CTCSS Decoder Unit EJ-28U Installation

As per diagram on the right, install the EJ-28U by mating the connectors.

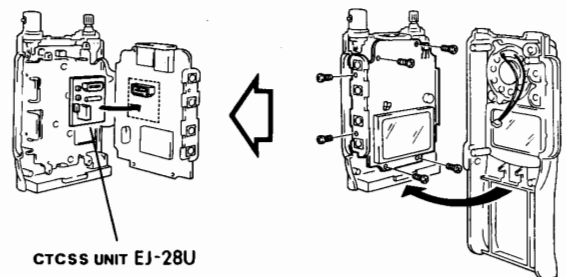

REFERENCE

● Charger EDC-63 (for 120VAC), EDC-64 (for 220VAC)

These chargers are for exclusive use of Ni-Cd Battery Packs used with ALINCO handheld transceiver. With EDC-63/EDC-64, the battery packs EBP-33N/34N/35N/36N/37N can be charged while it is attached to the transceiver.

< Installation >

Insert the battery-pack fully into the charger unit, matching the grooves. The red lamp will light up and charging will start.

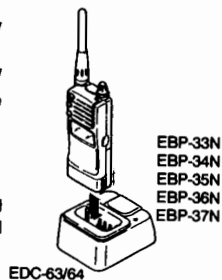

Caution

1. Turn off the transceiver power while charging.
2. Never charge the battery packs of other makes with this Charger.
3. The required charging time depends on the conditions and the models of battery pack. Refer to the instruction manuals of the battery pack.
4. Never short-circuit the charging terminals of this Charger with a metal object, etc. for the charger may be damaged by a strong current.
5. Precaution
Don't insert the above mentioned Ni-Cd batteries viceversa.
This mis-use causes damage on the drop in charger.
6. Never mount the battery pack in the charger backwards.
7. Charging should be conducted in the temperature range of 0°C to 40°C as incomplete charging or deterioration of battery performance may occur if charged outside this range.

● Ni-Cd Battery EBP-33N/34N/35N/36N/37N

Note

1. The battery pack is not charged when shipped. It must be charged before using.
2. Charging should be conducted in the temperature range of 0°C to 40°C, as incomplete charging or deterioration of battery performance may occur if charged outside this range.
3. Do not modify, dismantle, incinerate or immerse the battery pack in water as this may be dangerous. Be careful not to drop the battery pack or subject it to any severe shocks.

4. Never short-circuit the battery pack terminals, as this may cause damage to the equipment or lead to heating of the battery which may cause burns.
5. Unnecessarily prolonged charging (overcharging) may result in deterioration of battery performance.
6. The battery pack should be stored in a dry place with a temperature range of -20°C to +45°C. Temperatures outside this range or extremely high levels of humidity may lead to leaking of the battery liquid or resting of the metal components of the batteries.
7. Normally the battery pack can be charged up to 300 times. However, the battery pack can be considered to be exhausted if the period of use drops off markedly despite being charged for the aforementioned time. When this happens, a new pack should be used.
8.  ATTENTION: The battery that you have purchased is recyclable. At the end of its useful life, under various state and local laws, it may be illegal to dispose of this battery into the municipal waste stream. Check with your local solid waste officials for details in your area for recycling options or proper disposal.

Charging with EDC-63 or EDC-64 (Normal Charger)

1. Mount the Ni-Cd battery pack in the charger. The red lamp will light up and charging will start.
2. See table 2 for charging time. Dismount the battery pack from the charger after the charging.

Charging with EDC-60 or EDC-61 (Quick Charger)

1. Mount the Ni-Cd battery pack in the charger. The red lamp will light up and charging will start.
2. When the battery pack is mounted correctly, the red lamp will light up and quick charging will start.
When quick charging is completed, the red lamp will go off/the green lamp will light up. The charge rate will be then reduced to a weak supplementary charge rate to protect the battery pack from overcharging.

Specifications

	BATTERY CAPACITY	OUTPUT VOLTAGE
EBP-33N	650mAh	4.8V
EBP-34N	1200mAh	4.8V
EBP-35N	900mAh	7.2V
EBP-36N	650mAh	9.6V
EBP-37N	700mAh	4.8V

Charging Times and Chargers

	EDC-63 (for 120V) EDC-64 (for 220V)	EDC-60 (for 120V) EDC-61 (for 220V)
EBP-33N	Approx. 10 hours	Approx. 0.7 hour
EBP-34N	Approx. 18 hours	Approx. 1.2 hours
EBP-35N	Approx. 10 hours	Approx. 1.7 hours
EBP-36N	Approx. 10 hours	Approx. 1.2 hours
EBP-37N	Approx. 11 hours	Approx. 0.7 hour

The above times are required for completely discharged battery pack.

ATTENTION !

PREVENT SHORT-CIRCUITING OF THE NI-Cd BATTERY PACK

Be extra cautious when carrying the Ni-Cd battery pack; short-circuiting will produce surge current flow resulting in a possible fire.

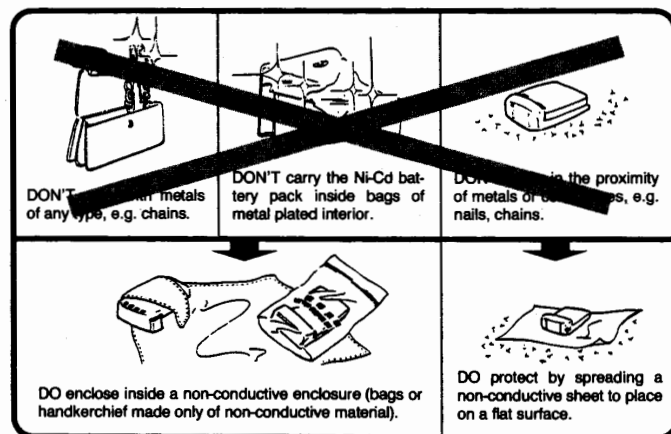
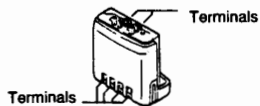

*For carrying, the battery pack should be kept in the bag provided.