

WILLSWING

Spectrum

144 and 165

Owner / Service Manual

Revised 3/26/91

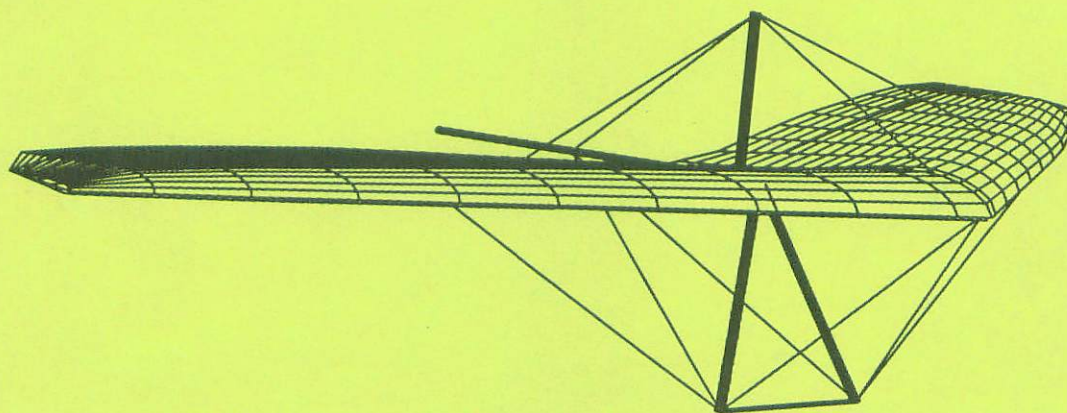

WILLSWING

1208 H. East Walnut Santa Ana, CA 92701 Phone (714) 547-1344 FAX (714) 547-0972



Spectrum 165
Spectrum 144

Owner / Service Manual

Copyright © 1991 by Sport Kites, Inc. dba Wills Wing, Inc. All rights reserved. No part of this manual may be reproduced in any form without the express written permission of Sport Kites, Inc., dba Wills Wing, Inc.

Wills Wing, Inc. 1208 H. East Walnut Santa Ana, CA 92701 Phone (714) 547- 1344

Table Of Contents

	Page
Introduction	3
Disclaimer and Warning	4
Technical Information and Placarded Operating Limitations	5 - 6
Shipping Breakdown and Re-Assembly	7 - 8
Glider Set-Up and Preflight	9 - 20
Launching and Flying	21 - 24
Trimming The Glider In Pitch	25 - 26
Landing	27 - 29
Breakdown	30 - 33
Stability Systems	34
Maintenance	35 - 36
Removing and Re-Installing The Sail	36 - 38
Tuning	39 - 40
Car Top Mounting and Closing Message	40
Compliance Verification Specification Sheets	41 - 42
Frame Plans and Exploded Views	43

INTRODUCTION

Thank you for purchasing a Wills Wing glider, and welcome to the world wide family of Wills Wing pilots. We are a company of pilots and aviation enthusiasts, and our goal is to serve your flying needs now and in the future, as we have done for pilots throughout the world since 1973.

We encourage you to read this manual thoroughly for information on the proper use and maintenance of your Wills Wing glider. If at any time you have questions about your glider, or about any aspect of hang gliding that your Wills Wing dealer cannot answer, please feel free to give us a call.

We wish you a safe and enjoyable flying career, and, once again, welcome aboard!

*Rob Kells, Mike Meier, Linda Meier, and Steve Pearson
Wills Wing, Inc.*

DISCLAIMER AND WARNING

Hang gliding is a form of aviation. Like any form of aviation, its safe practice demands the consistent exercise of pilot skill, knowledge of airmanship and weather, judgement and attention at a level which is appropriate to the demands of each individual situation. Pilots who do not possess or exercise the required knowledge, skills and judgement are frequently injured and killed. The statistical rate at which fatalities occur in hang gliding is approximately one per thousand participants per year.

The Federal Aviation Administration does not require a pilot's license to operate a hang glider. Hang gliders and hang gliding equipment are not designed, manufactured, tested or certified to any state or federal government airworthiness standards or requirements. Wills Wing hang gliding products are not covered by product liability insurance. You should never attempt to fly a hang glider without having received competent instruction. We recommend that you not participate in hang gliding unless you recognize and wish to personally assume the associated risks.

Please fly safely.

Wills Wing, Inc.

TECHNICAL INFORMATION AND PLACARDED OPERATING LIMITATIONS

The Spectrum 165 and Spectrum 144 have been tested and found to comply with the 1990 HGMA Airworthiness Standards. These standards require:

- 1) A positive load test at root stall angle of attack at a speed of at least 65 mph for at least three seconds without failure.
- 2) A negative 30 degree angle of attack load test at a speed of at least 46 mph for at least 3 seconds without failure.
- 3) A negative 150 degree angle of attack load test at a speed of at least 32 mph for at least 3 seconds without failure.
- 4) Pitch tests at speeds of 20 mph, 30 mph and 40 mph which show the glider to be stable over a range of angles of attack from trim to negative 20 degrees at 20 mph and from trim to negative 10 degrees at 30 mph and from trim to zero lift angle of attack at 40 mph.
- 5) Flight maneuvers which show the glider to be adequately stable and controllable throughout the normal range of operation.

NOTE: The Spectrum 165 and Spectrum 144 have been designed for footlaunched soaring flight. They have not been designed to be motorized, tethered, or towed. They have been towed successfully using the ATOL truck towing system, and are approved for towing in this manner **provided that all specific ATOL procedures and safeguards are followed. It is the pilot's obligation to contact ATOL directly for all recommended procedures for using the ATOL tow system.**

In particular, please note the diagrams below showing the correct and incorrect way to attach a nose line for ATOL towing. Attaching the line incorrectly may result in the bottom front wires becoming disconnected during release from the tow vehicle resulting in loss of control of the glider. (Figure 1, 2)

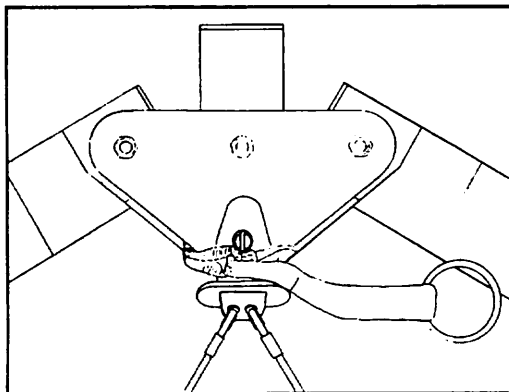

Figure 1 **CORRECT**

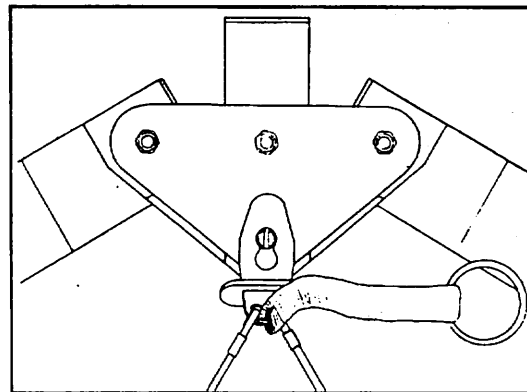

Figure 2 **WRONG - UNSAFE!**

VIEW FROM BELOW THE NOSEPLATE

Flight operation of the Spectrum should be limited to non aerobatic maneuvers; those in which the pitch angle will not exceed 30 degrees nose up or nose down from the horizon, and the bank angle will not exceed 60 degrees. The Spectrum will resist spinning, and will recover from a spin once control pressures are relaxed. As the nose lowers and the angle of attack is reduced, the stall will be broken and the spin will stop. No attempt should ever be made to deliberately spin the glider, as loss of control, in flight inversion, and structural failure may result.

The maximum steady state speed for a prone pilot in the middle of the recommended weight range full forward on the control bar is approximately 46 mph for the Spectrum. This is the VNE (speed never to exceed) for this model. At no time, but especially in rough air, or when abrupt maneuvering is anticipated, should the Spectrum be flown faster than 46 mph. The stability and structural strength of the Spectrum within the placarded operating limitations have been tested and found to be adequate for normal operation. However, the Spectrum is a high performance glider, and a degree of pitch authority is provided to the pilot which will allow the pilot to exceed the placarded limiting airspeed. At speeds above VNE, or angles of attack below that which corresponds to VNE, the pitch stability and / or structural safety margin may not be adequate to insure safe operation.

The stall speed of the Spectrum at maximum recommended wing loading is 25 mph or less. The top (steady state) speed at minimum recommended wing loading for a prone pilot with a properly designed and adjusted harness is at least 40 mph.

All speeds given above are indicated airspeeds, for a properly calibrated airspeed indicator mounted in the vicinity of the pilot. It is strongly recommended that the pilot fly with such an airspeed indicator at least as many times as is necessary to become acquainted with what control bar positions and what kinesthetic sensory stimuli correspond to the various placarded limiting airspeeds.

The recommended hook in pilot weight range for the Spectrums are:

Spectrum 165: 140 - 240 lbs.

Spectrum 144: 120 - 210 lbs.

A minimum USHGA Novice (II) level of pilot proficiency, and the ability to demonstrate this proficiency level on the Spectrum or other glider of equivalent performance is required to fly the Spectrum safely. Operation of the glider by unqualified pilots may be dangerous.

Operating the Spectrum outside of the above limitations may result in injury and death. Flying the Spectrum in the presence of strong or gusty winds, or turbulence may result in loss of control of the glider which may lead to injury and death. Do not fly in such conditions unless you realize and wish to personally assume the associated risks. Wills Wing is well aware that pilots have, and continue to perform maneuvers and fly in conditions which are outside the recommended operating limitations stated herein. Please be aware that the fact that some pilots have exceeded these limitations in the past without dangerous incident does not imply or insure that the limitations may be exceeded without risk. We do not know, and cannot know, the full range of maneuvers or conditions which may cause the pilot's safety to be compromised, nor can we test the glider in all possible circumstances.

SPECTRUM BREAKDOWN PROCEDURE FOR SHIPPING AND RE-ASSEMBLY PROCEDURE

The Spectrum can be broken down to approximately 13.5 feet by removal of the rear leading edges.

TO BREAK DOWN THE LEADING EDGES FOLLOW THESE STEPS:

1) Lay the glider on the ground or floor, unzip and remove the bag and remove the velcro ties. Undo the velcros which hold the sail around the sail mount plug and pull the sail rearward at each tip to dismount the sail from the rear leading edge.

2) Obtain an indelible marker. Mark the rear leading edges left and right (remember that left and right are reversed if the glider is lying "on its back", upside down. Push the sail up to where you have uncovered the point where the rear leading edge exits the front. Mark a line along the leading edge across the joint between front and rear leading edge on each leading edge. This mark will guide you in properly realigning the rear leading edges into the fronts during re-assembly.

3) If the mylar is to be removed from the mylar pocket, do so at this time. At the tip, inside the sail under the mylar pocket, make a small hole and tie or securely tape a 25' long piece of leech line to the mylar. Remove the top plastic kingpost cap and disconnect the top side wire from the kingpost. Replace the cap. Pull the top side wire through to the inside of the sail. Pull the sail back down the length of the leading edge but do not remount it to the rear. Pull the mylar out from the nose of the glider, curling it under where it exits the front of the mylar pocket to that it will fit through the opening. If the mylar sticks, work up and down the edges of the mylar along the mylar pocket, breaking the edges of the mylar away from the seamstick tape in the seams.

4) Spray silicone spray lubricant on the rear leading edge at the point where it exits from the front.

5) Remove the small safety ring and then the 3/16" clevis pin which secures the rear leading edge in the front. Pull the rear leading edge straight aft to disengage it from the front. Put tape on the sharp edges of the front end of the rear leading edge tubes, and on the rear end of the front leading edge tubes.

6) Carefully fold the rear of the sail over against the front, and replace the bag on the glider.

RE-MOUNTING THE REAR LEADING EDGES

- 1) Make sure you are mounting the correct leading edge rear into the correct front (check "right" / "left" designation).
- 2) Spray the forward six inches of the rear leading edge with silicone spray lubricant.
- 3) Slide the rear leading edge into the front, lining up the rotational alignment marks you made during breakdown, until the rear engages fully in the front leading edge, as indicated by the alignment of the clevis pin hole.
- 4) Re-install the top side wire if removed.
- 5) Pull the sail down the leading edge and re-install the mylar if removed. **CAUTION: IF YOU USED TAPE TO PULL THE STRING INTO THE MYLAR POCKET, YOU WILL HAVE TO PUNCH A HOLE IN THE MYLAR AND TIE THE STRING TO THE MYLAR TO RE-INSTALL IT. OTHERWISE THE STRING WILL PROBABLY COME DETACHED FROM THE MYLAR.**
- 6) Remount the sail to the rear leading edge, making sure to align the sail mount webbing square in the slot and attach the securing velcros.

SPECTRUM SET UP PROCEDURE

1) With the glider in the bag, lay the glider on the ground, zipper up with the nose into the wind. (Figure 3)

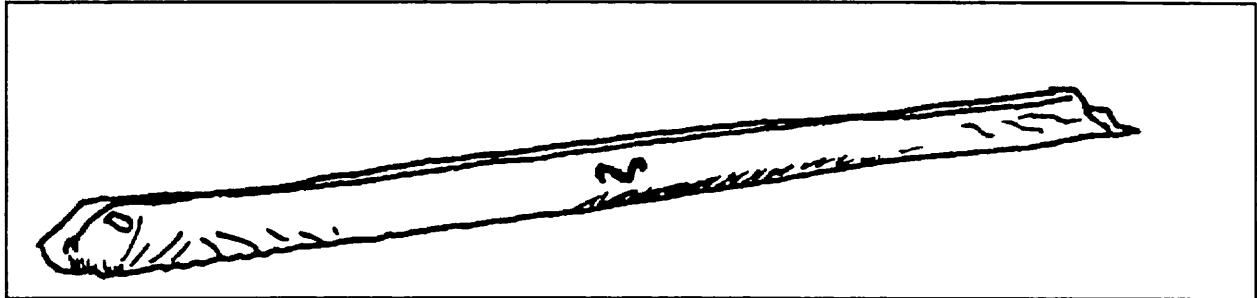

Figure 3

2) Undo the zipper, remove the battens and the control bar cover bag. (Figure 4 & 5)

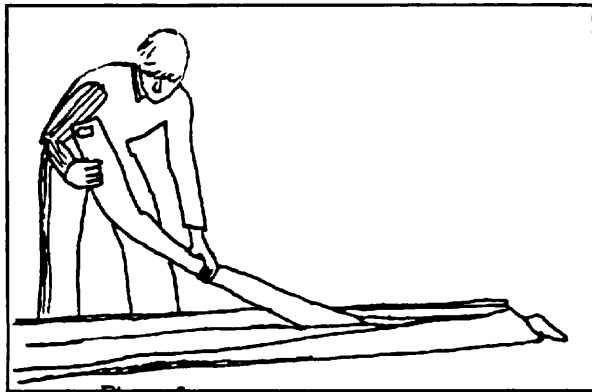

Figure 4

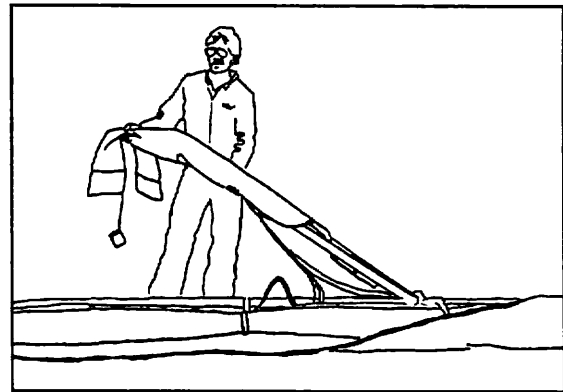

Figure 5

3) Lift the control bar and attach the basetube to the upright, using the bolt, wingnut and safety provided. (Figure 6 & 7)

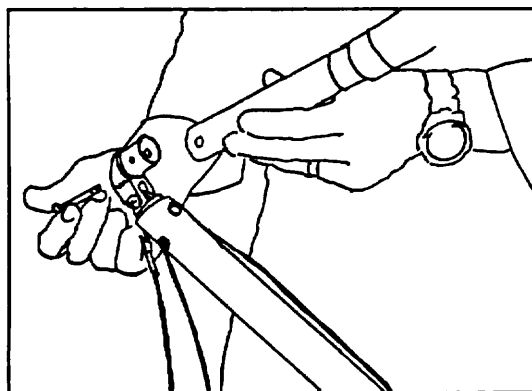

Figure 6

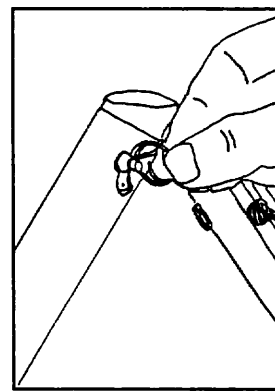

Figure 7

4) Flip the glider upright on the control bar, and remove the bag and all velcro ties. (Figure 8) *Do not remove the leading edge tip protector bags at this time. Do loosen the velcro on the tip protector bags as much as possible without detaching it.*

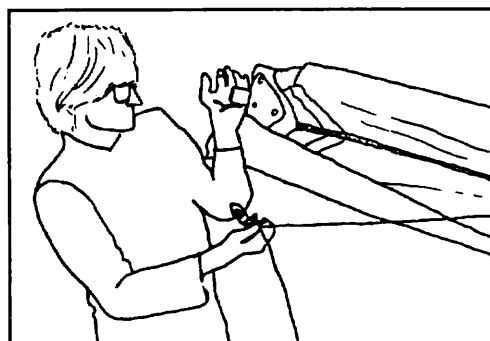

Figure 8

If there is more than ten mph of wind, turn the glider 90 degrees to the wind.

5) Spread the wings almost all the way. Lift the kingpost, remove the top kingpost protector, and set the kingpost on the kingpost base ridge on the keel, *making sure the CG locating pin engages in the slot in the track.* (Figure 9 and 10)

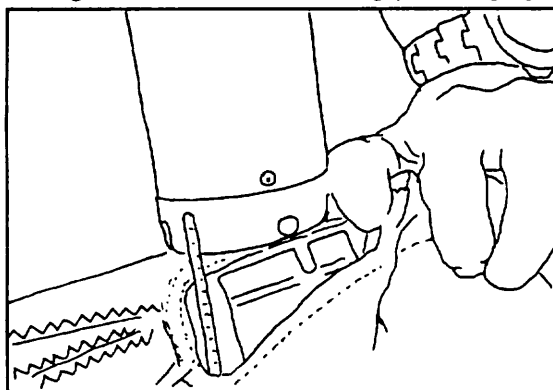

Figure 9

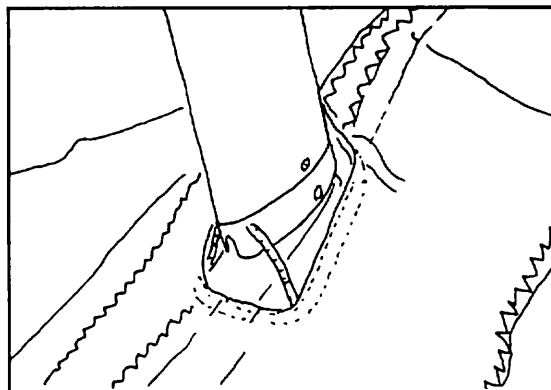

Figure 10

6) Attach the bridle ring to the bridle snap clip, making sure that the bridle cables are not twisted, and that the bridles are *outside* the top rear wire. (Figure 11)

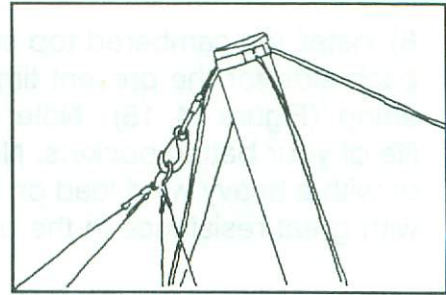

Figure 11

7) Attach the top rear wire to the rear keel bolt, making sure again that the bridle cables are *inside* the wire, and attach the rubber safety. (Figure 12)

Check each pair of the curved top surface battens for side to side symmetry. (Figure 13)

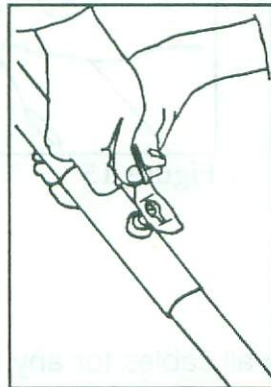

Figure 12

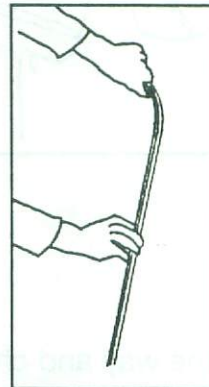

Figure 13

8) Install the cambered top surface battens in the sail, leaving out the shortest three on each side for the present time. Each batten is secured by a double loop of the batten string. (Figure 14, 15) Note: Insert the cambered battens carefully, so as to prolong the life of your batten pockets. Never insert or remove battens with the crossbar tensioned, or with a heavy wind load on the sail, or in any condition that causes the battens to slide with great resistance in the pockets.

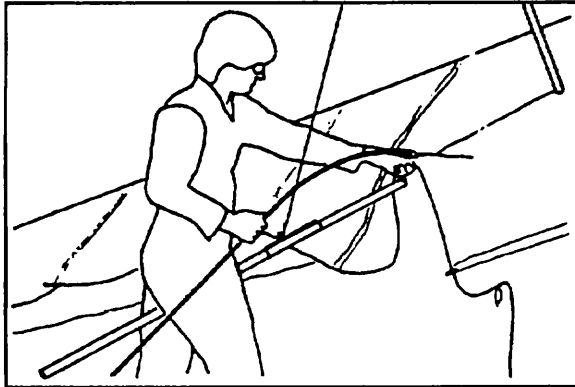

Figure 14

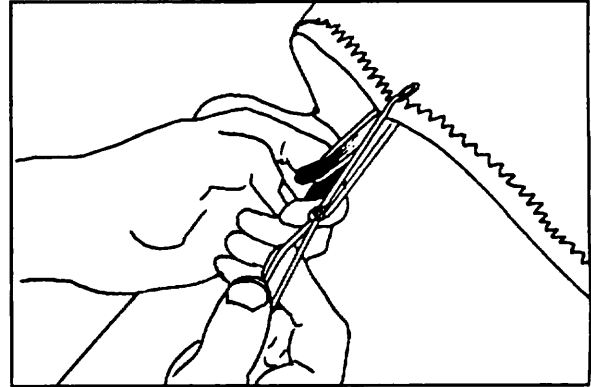

Figure 15

9) Spread the wings all the way and check all cables for any twisted thimbles or tangled cables. (Figure 16, 17)

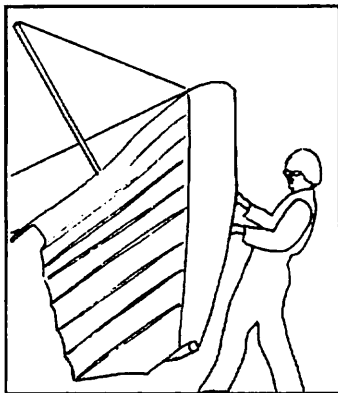

Figure 16

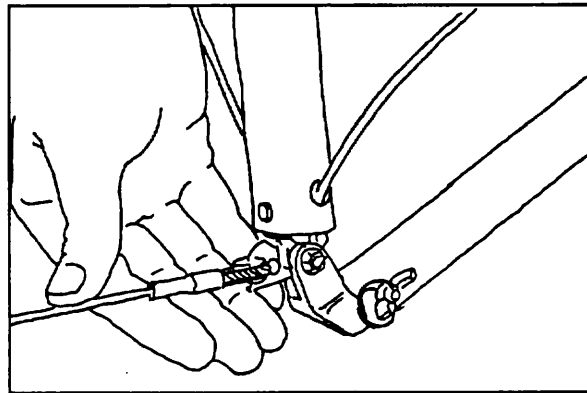

Figure 17

10) Standing under the glider just in front of and facing the control bar, remove each side of the apex protector pad from the control bar apex (if so equipped; with streamlined downtubes only) and stow it inside the double surface. (Figure 18)

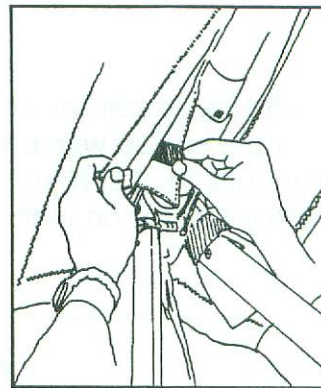

Figure 18

11) The next step is to pull the xbar center back in order to connect the xbar anchor cables. At this point there are two alternate methods for pulling back the crossbar; by hand or using your foot.

a) If the perlon line is already threaded around the horizontal apex bolt, (streamlined downtubes only) back through the xbar wire pullback cable thimble, and tied in a large loop, the glider is set up to be tensioned using your foot. In this case, merely step into the loop in the perlon line, and step down and back to pull back the crossbar. (If the glider is not configured this way, it is easy to convert it to this configuration. Just make sure that the loop is tied far enough down in the perlon that the crossbar center is free to fold all the way forward during breakdown).

b) To pull the crossbar back by hand, first thread the perlon line attached to the xbar wire around the horizontal bolt in the center of the control bar apex (streamlined downtubes), or around the top of the downtube (round downtubes) and then back through the thimble on the crossbar pull back wire and pull back on the perlon to pull the crossbar back. When you have the crossbar back far enough to attach the VG activation cable, wrap the perlon line around the top of the downtube and temporarily tie it off. (Figure 19, 20)

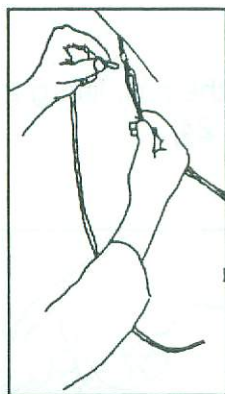

Figure 19



Figure 20

13) Next, install the crossbar sweep wire restraint bolt through the keel, attach the thimble for the sweep wire on the other side, and secure it with the wingnut and safety provided. (Figure 21, 22) **If you tied off the perlon pullback, untie and release it *now*.** You may stow the perlon in the bottom surface.

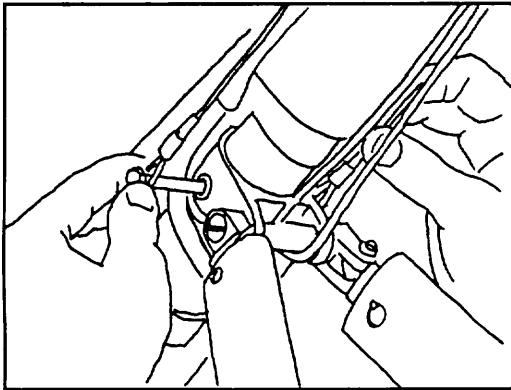

Figure 21

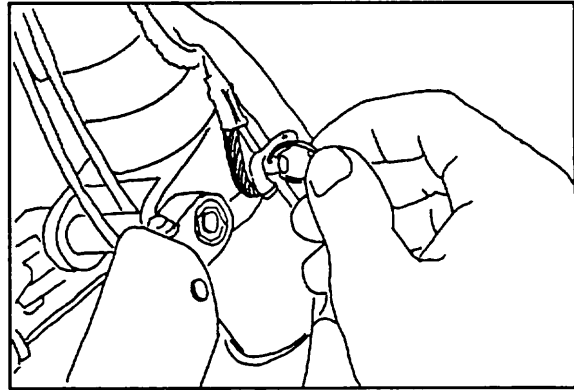

Figure 22

16) Attach the bottom front wires to the bottom of the nose, by pulling down on the nose of the glider while pressing the tang upwards over the shouldered bolt. (Remember, it is the pulling down of the glider's nose rather than the upward pressure on the tang that allows you to install the tang over the bolt. If you have difficulty with installing the tang, and no wires are twisted or thimbles cocked, it is probably because the glider is not sitting on level ground.) (Figure 23)

17) Push the nose batten all the way back into the sail, lifting the tip over the top of the keel until it is seated on top of the keel. (Figure 24)

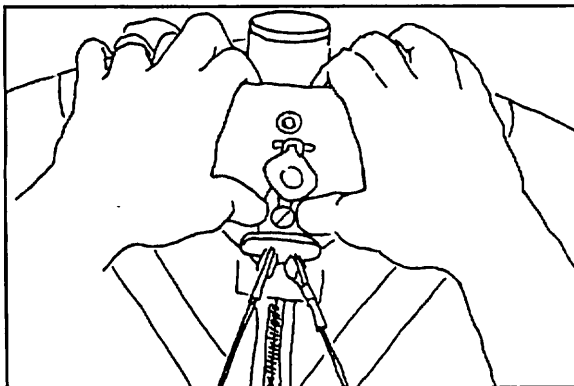

Figure 23

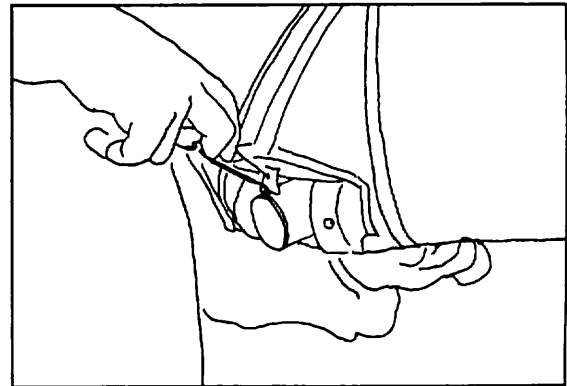

Figure 24

18) Remove the wingtip protector bags, and remove the plastic wingtip fairings from inside the bags. (Figure 25) Install the last three curved battens on each side.

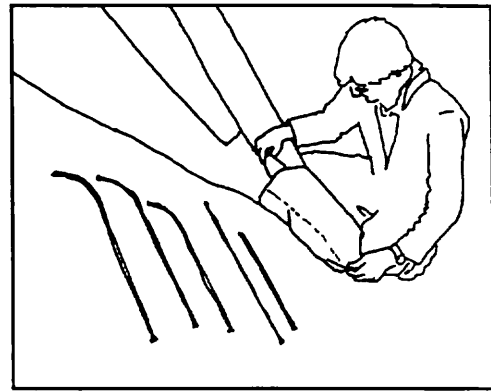

Figure 25

20) Install the plug in #1 battens. (Figure 26, 27)

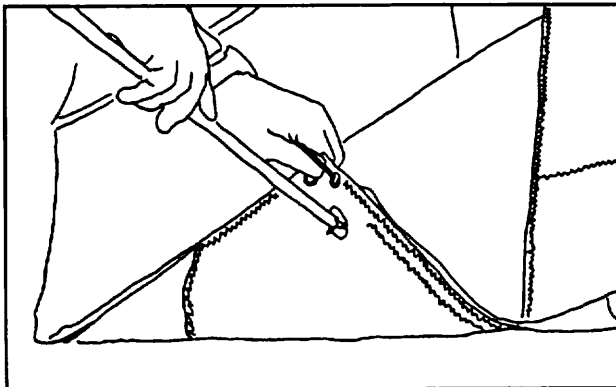

Figure 26

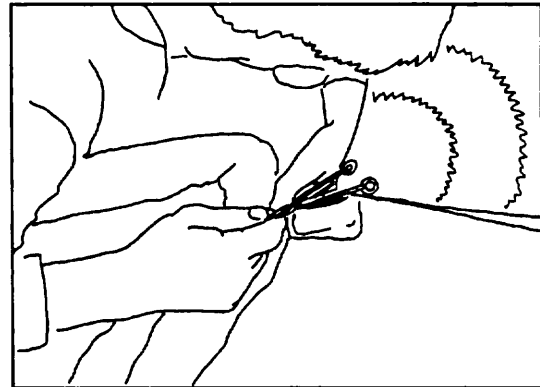

Figure 27

21) At this time preflight the sail mount webbing, making sure that it is fully engaged and square in the slot in the sail mount plug endcap.

Also, at this time look up into the wing and preflight the #1 batten connection, the front to rear leading edge junction, and the crossbar leading edge junction, checking that all safety rings are installed, etc.

22) Install the plastic wing tip covers using the following procedure:

- a) Hold the wingtip fairing in one hand, slightly squeezing the fairing together.
- b) Lift the rear tip of the #1 batten until the sail at the tip is equally tensioned on both the top and bottom surfaces.
- c) Slide the tip fairing into the end of the sail and press the mating velcro surfaces securely together. (Figure 28, 29)

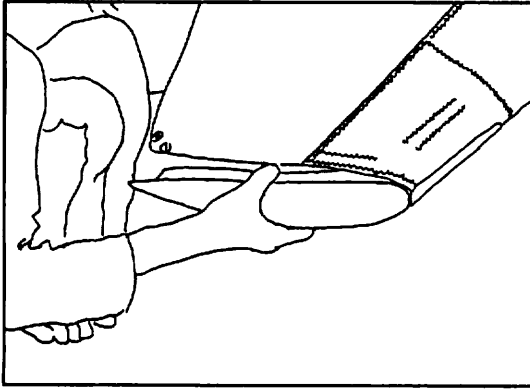

Figure 28

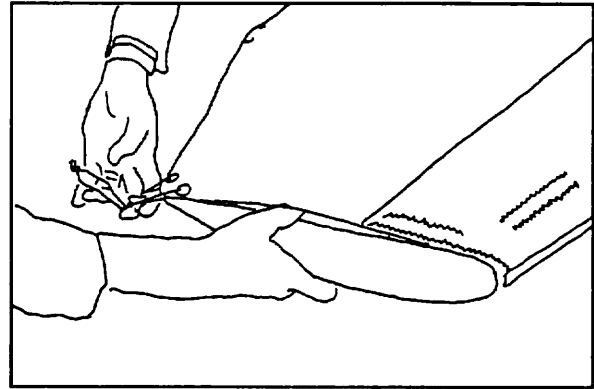

Figure 29

Make sure that the raised ridge on the wingtip fairings lies flush against the edge of the sail, that there are no large gaps in the mating of the fairing to the sail, and that the velcro is securely fastened both top and bottom.

23) Install the bottom surface battens.

(Figure 30) Depending on the production date of your glider, these will have either:

- a) No provision for securing the rear end of the batten.
- b) A folded pocket termination at the aft end of the pocket to secure the rear end of the batten.
- c) A velcro tab at the aft end of the pocket to secure the rear end of the batten.

If there is a provision for securing the batten end, secure it. If not, check your BS battens just before launch to make sure they have not backed out.

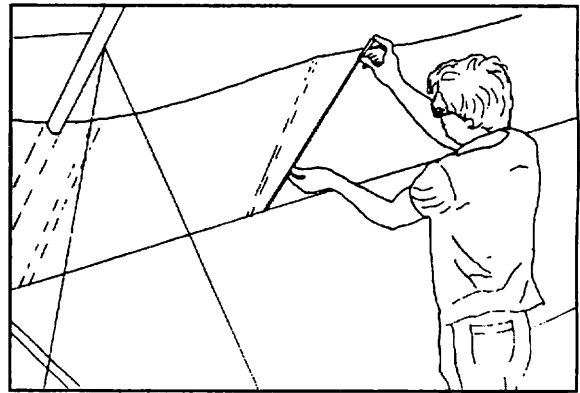

Figure 30

24) Starting at the nose, and working around the glider, do a complete pre-flight of the assembled glider, checking all nuts, bolts, safeties, fittings, cables, battens, etc.

AT THE NOSE:

Check the security of all nuts at the noseplate, and that the safety ring is in place above the nut which is on top of the rear keel noseplate bolt. (Figure 31)

Lock in through the nose and visually check the crossbar center junction (safety ring in place on bottom of crossbar hinge bolt) and leading edge / crossbar junction (safety ring in place). (Figure 32)

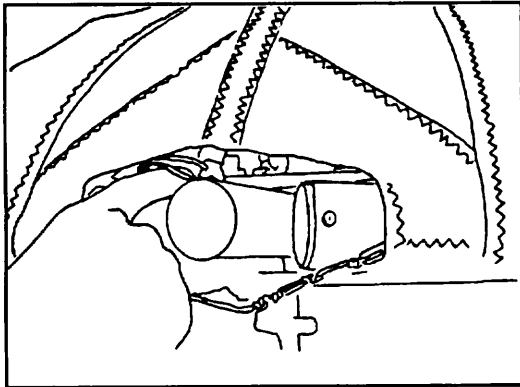

Figure 31

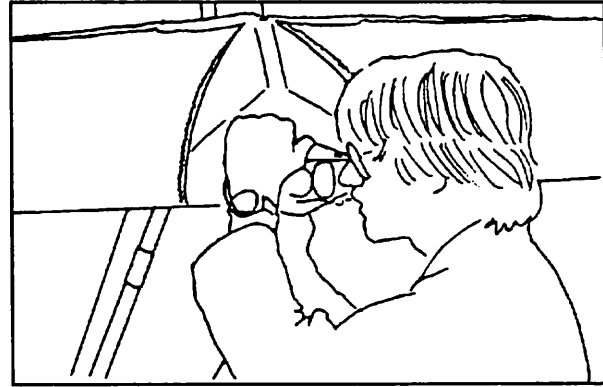

Figure 32

ALONG THE LEFT LEADING EDGE:

While pushing up on the leading edge between the nose and the crossbar junction, step on the bottom side wire with about 75 lbs. of force. This is a rough field test of the structural security of the side wire loop, the control bar, the kingpost, and the crossbar, and would likely reveal a major structural defect that could cause an inflight failure in normal operation. (Figure 33)

Open the crossbar junction access zipper and reach inside, making sure you can feel that the safety ring on the junction bolt is in place. (Figure 34) Re-close the zipper.



Figure 33

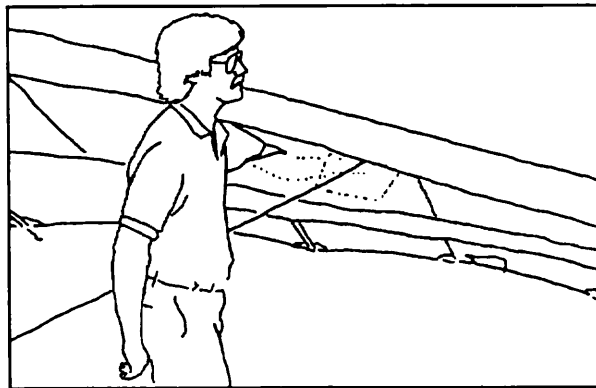

Figure 34

AT THE LEFT TIP:

You have already preflighted those parts of the glider accessible only with the tip fairing removed. At this time, check the tip again for secure and proper installation, and that the washout tip (if so equipped) is securely installed.

ALONG THE TRAILING EDGE, LEFT WING:

Check that there are no tears in the sail material along the trailing edge. (Figure 35)

Check that all batten strings are properly secured.

Check that the bridles are properly engaged, with the plastic retainer balls fully seated against the grommet, and that no bridle cable is hooked underneath a more inboard batten. (Figure 36, 37)

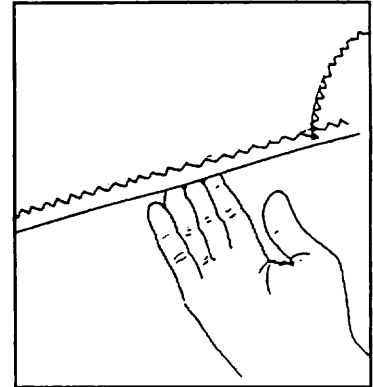

Figure 35

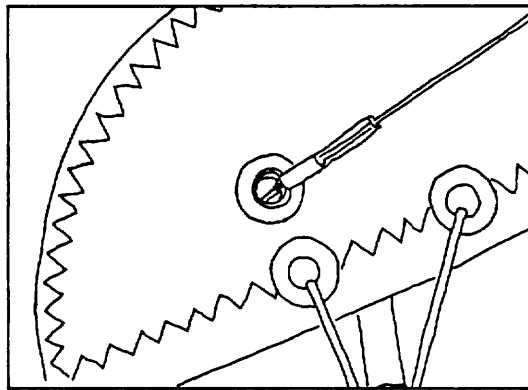

Figure 36

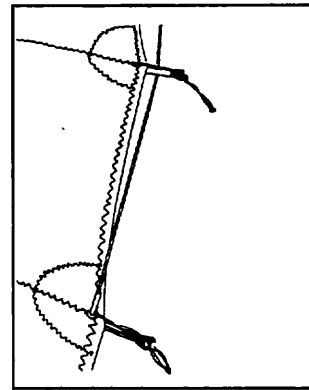

Figure 37 WRONG!

FROM THE REAR KEEL:

Check that the kingpost is properly and securely seated on the keel, and that the pin is fully engaged in the slot. (Figure 38)

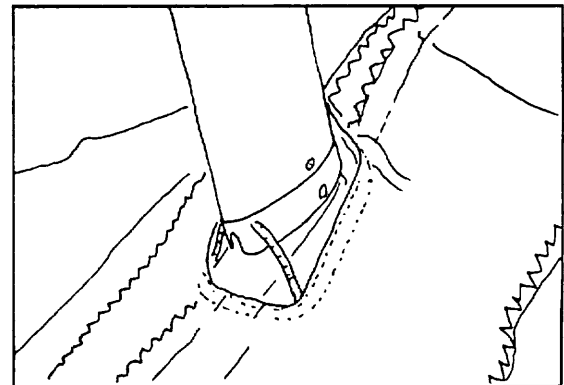

Figure 38

Check again that the bridles are properly routed *outside* of the top rear wire, and that no thimble or bridle cable is twisted or kinked. (Figure 39)

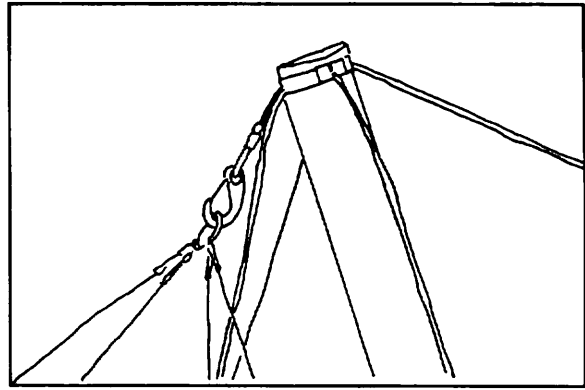

Figure 39

ALONG THE TRAILING EDGE, RIGHT WING:

Same as for left wing.

AT THE RIGHT TIP:

Same as for left tip.

ALONG THE RIGHT LEADING EDGE:

Same as for left leading edge.

UNDER THE GLIDER, AT THE CONTROL BAR:

Sight down the downtubes, making sure that they are straight. Check that the hang loop is positioned where you want it (proper fore and aft location for the desired trim) and that the velcro cinch strap is tight and secure. (Figure 40)

Check the cables at the control bar corners, making sure there are no kinks or twisted thimbles. (Figure 41) Check for proper installation of all nuts and safety rings at the control bar corners.

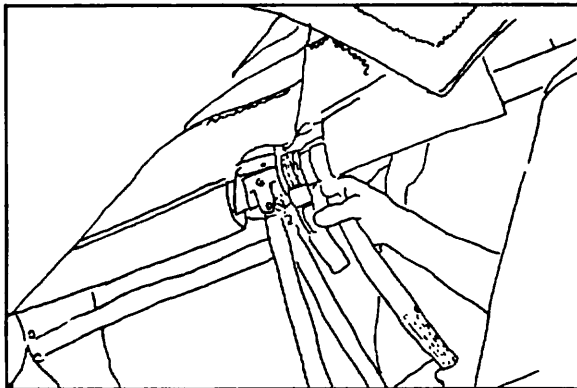

Figure 40

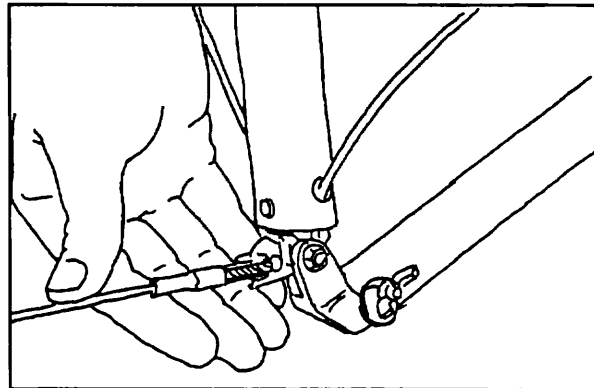

Figure 41

At the apex, check the nuts on the elbow to top fitting junction, the nut on the horizontal apex bolt, and the safety rings on the top fitting clevis pins. (Figure 42)

Check the safety on the clevis pin which secures the sail at the rear keel pocket, and the nut on the bottom of the rear wire bolt. (Figure 43)

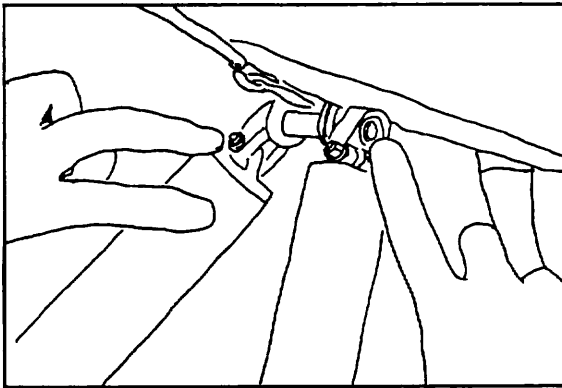

Figure 42

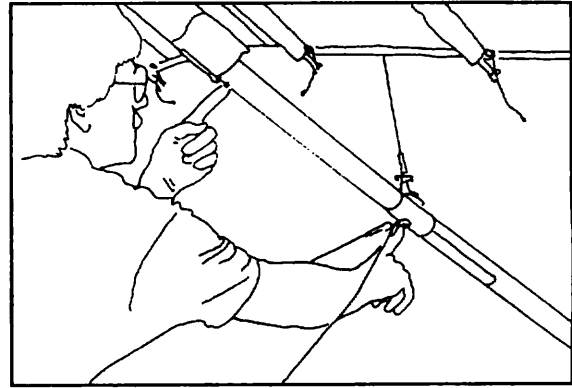

Figure 43

Zip the center zipper closed.

25) Install the nose cone, mating the velcro surfaces together carefully, and making sure that the nose cone lies flat against the sail on both the top and bottom of the sail. (Figure 44, 45)

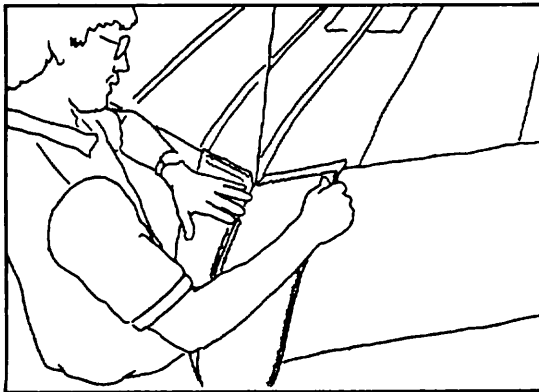

Figure 44

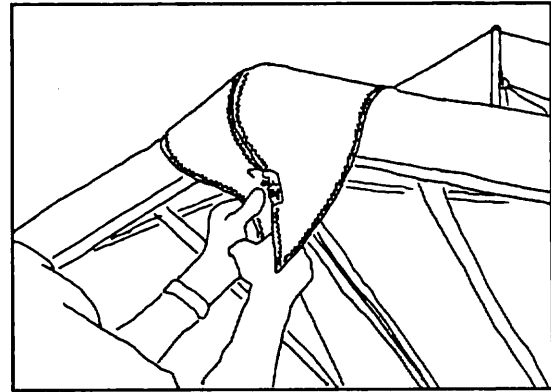

Figure 45

26) Have someone hold the glider by the nose or rear keel (at the rear wire station), hook in and do a hang check, making sure that your harness and parachute clear the basetube through the full range of motion.

LAUNCHING AND FLYING THE SPECTRUM

- 1) If the wind is more than 10 mph or gusty you should have an assistant on your nose wires on launch, and, if necessary, an assistant on one or both side wires. Make sure all signals are clearly understood. Do a hang check immediately prior to launch. The angle at which you hold the glider should depend on the wind speed and slope of the terrain at launch; you want to achieve a slight positive angle of attack at the start of your run.
- 2) Run aggressively on launch and ease the bar out for lift off.
- 3) The flying characteristics of the Spectrum are typical of a moderate aspect ratio high performance flex wing. Make your first flights from a familiar site in mellow conditions to give you time to become accustomed to the glider.
- 4) We recommend that you hang as close as possible to the basetube in the glider - this will give you lighter control pressures and better control.

USING WING TUFTS

Your Wills Wing glider has been equipped from the factory with short yarn tufts on the top surface of each wing. The shadow of these tufts will be visible through the sail. The tufts are useful for indicating the local reversal of the airflow which is associated with the onset of the stall in that portion of the wing. You can use these tufts, as described below, to help determine when you are flying at minimum sink airspeed.

There are two important airspeeds with which all hang glider pilots should be intimately familiar; minimum sink airspeed (hereinafter referred to as MSA) and minimum controllable airspeed (MCA). **The most important of these two is MCA.** Minimum sink airspeed is that speed at which your descent rate is the slowest possible. It is the speed to fly when you want to maximize your climb rate in lift, or slow your rate of descent to a minimum in non lifting air. (You would normally not fly at MSA in sinking air; the strategy there is normally to speed up and fly quickly out of the sink. By minimizing your time spent in the sinking air you minimize altitude lost, even though you have momentarily increased your sink rate by speeding up.)

Minimum controllable airspeed is that speed below which you begin to rapidly lose effective lateral control of the glider. Recognition of this speed and its implications is a more subtle problem than many pilots realize. We have seen several instances of pilots who were having a lot of trouble flying their gliders simply because they were unknowingly trying to fly them too slowly; below the speed at which the glider responded effectively to lateral control inputs. It is our opinion that a great percentage of hang gliding accidents are caused by inadvertent flight below MCA, and subsequent loss of control of the glider with impact preceding recovery. Such incidents are usually attributed to "stalls," but it is not the stall per se that causes the problem, indeed the glider need not even be "stalled" in the traditional sense.

There is no necessary cause and effect relationship between minimum sink speed and minimum controllable airspeed. MSA is determined primarily by the wing loading and span loading, the wing planform, the wing section characteristics, etc. MCA is influenced most heavily by the tension in the sail; how much "billow" the glider has. However, in most hang gliders, MCA and MSA evolve towards a common value during the design and development of the glider. This is so because if the wing is tuned so tight that minimum controllable airspeed is at a higher speed than minimum sink speed, then effective sink rate performance can be improved by loosening the wing so as to lower the minimum controllable airspeed. Conversely, if minimum controllable airspeed is reached at a speed below that of minimum sink, the wing can usually be tightened so as to improve glide performance without significant sacrifice in other areas. On the Spectrum, an extra degree of controllability at low speeds has been designed into the glider, in order to make the response characteristics more forgiving when the glider is flown at or near minimum sink speed. As a result, it is quite possible to fly the glider below minimum sink airspeed and still control it. There is no benefit to doing so, however, as your performance is worse than it would be at a slightly higher speed.

USING WING TUFTS TO FIND THE MINIMUM SINK SPEED OF YOUR GLIDER

On a flex wing hang glider, the wing experiences a gradual and progressive stall, and different spanwise stations of the wing stall at different angles of attack. Contrary to popular belief, a hang glider wing does not stall first in the root or center section. It is true that because of wing twist the root section is at the highest angle of attack relative to the remote free stream airflow, but other factors influence the stall propagation on the wing. Specifically, a flex wing hang glider stalls first somewhere in the midspan of each wing, approximately one third of the way out from the root to the tip, where your tufts are located. As the angle of attack is raised further, the stall propagates both outward towards the tips and inward towards the root. If you wish to observe the stall propagation across the whole wing on your glider, you can cut some more tufts from knitting yarn, about 3-4" long, and tape these to the top surface of your sail across the rest of the span.

During normal flight the flow will be chordwise along the wing, and the tufts will point towards the trailing edge. (Figure 46) When the wing stalls, the tufts will reverse direction, indicating the local flow towards the leading edge. (Figure 47)

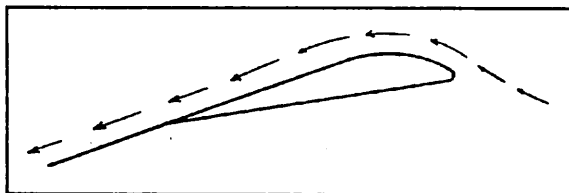

Figure 46

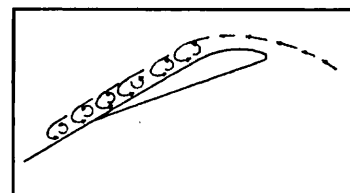

Figure 47

At the first onset of stall, the tufts will sometimes indicate the impending separation by first wiggling, and then deflecting spanwise, before they fully reverse and point forward. The first onset of stall in the midspan occurs well before the familiar "stall break" in which the glider pitches uncontrollably nose down to recover from the stall. By the time the stall break occurs, all tufts but those farthest outboard and those farthest inboard will have indicated reversed flow.

The first onset of midspan stall as indicated by the first tickling of the tufts indicates that you have reached the angle of attack corresponding to the glider's minimum sink airspeed. This will also be close to the glider's minimum controllable airspeed. (Figure 48)

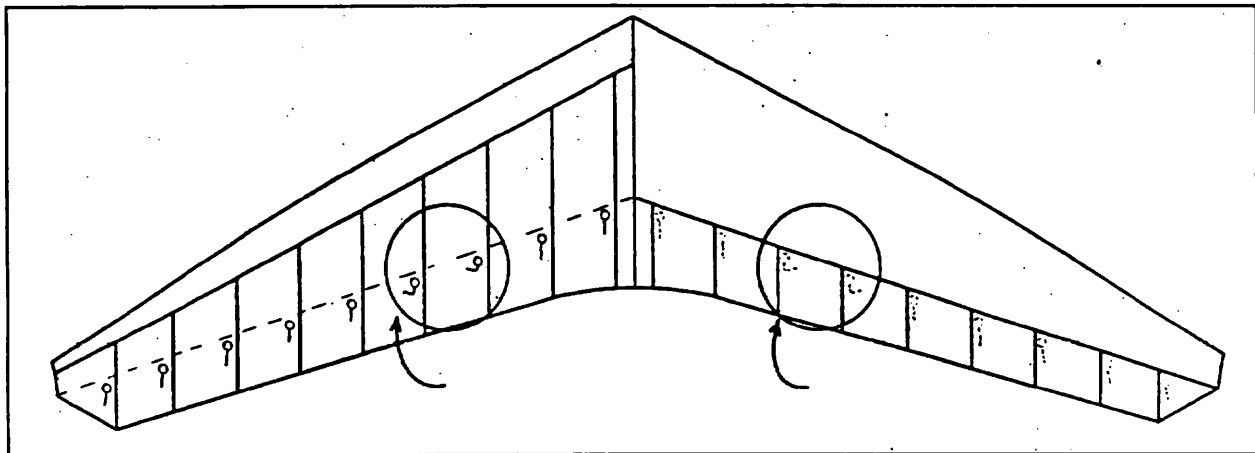

Figure 48 Left shows top view, right shows pilot's view from bottom.

To find the glider's minimum sink speed, fly the glider in smooth air, early in the morning or late in the afternoon. When you are well away from the terrain, and well clear of other aircraft, look up at the wing tufts while you very gradually reduce the speed of the glider. Note the speed at which the first tuft first begins to wiggle just prior to blowing spanwise toward the tip. (If the tufts contain static electricity, they may not show this lateral wiggle prior to reversal. However, you may get other clues to the beginning of separation, such as slight flutter or rumble in the top surface of the sail.) This is your speed for minimum sink rate. Familiarize yourself with the position of the control bar relative to your body at this speed, with the sound and feel of the wind, with the reading on your airspeed indicator if you use one, and with the feel of the glider in terms of pitch and roll pressures. Most of the time when you are flying it will not be practical to look up for extended periods of time at your tufts. That is why familiarization with these other, more accessible indicators is important.

After finding your minimum sink speed, experiment with roll control response at speeds just above and just below this speed to find the value of MCA and the corresponding bar position and other indicators for this speed. Realize that your effective MCA is going to be higher and higher as the air becomes more and more turbulent; control response that is perfectly adequate in smooth air will not be good enough in rougher air. Try flying the glider with the midspan tufts fully reversed; you will probably find that the glider is controllable, but only with an increased level of physical effort. Note that both MCA and MSA come well before the glider actually "stalls" in the traditional sense, i.e. pitches uncontrollably nose down. You may also be able to sense, or your vario may tell you that although the glider has not "stalled" (pitched nose down) your sink rate has increased significantly. In this mode the glider is "mushing."

Once you have familiarized yourself with the glider's characteristics in this range of speeds, you will not need to look at the tufts very often. You will know from bar position and bar pressure, and from the sound and feel of the relative wind when you are at your minimum sink or minimum controllable airspeed. In general, you should not fly your glider below minimum sink speed. Be aware, however, that when you are flying at minimum sink in thermal gusts and turbulence, you will experience gust induced separation of the airflow which will periodically cause the tufts on your sail to reverse.

Of course in a turn, your minimum sink SPEED goes up because you are banked, and the bank effectively increases your wing loading which increases your flying SPEED for any angle of attack. But note this: THE TUFTS INDICATE ANGLE OF ATTACK, WITHOUT REGARD TO AIRSPEED! Therefore, if you practice flying various bank angles in smooth air (while well away from any terrain or other gliders) and watch your tufts (on the inside wing, which will be at the highest angle of attack) you will get a feel for the way your minimum sink speed varies at varying bank angles.

Also be aware that in some thermalling situations, such as when trying to maximize climb rate in a thermal with a very strong and very small core, there may be an advantage in overall effective climb performance to flying so slowly that some portion of the inside wing is partially stalled most of the time. This is, however, an advanced and potentially dangerous technique - it is the beginning of a spin entry, and if pushed just a little too far can result in a sudden and extreme loss of control and / or altitude. In general, if the tufts are indicating flow reversal associated with the stall, you will improve both performance and controllability by pulling in and speeding up a little.

One final caution: from time to time a tuft may stick completely to the sail, and fail to properly indicate the direction of local flow. This may result from static buildup, or from the fine threads of the yard becoming caught on a seam or some dirt or imperfection in the sail. The tuft may stick while indicating normal flow, but most often it will stick after having reversed, such that the tuft will indicate a stalled condition that does not exist. One clue in this situation is to note whether or not the tuft is wiggling. Since flow reversal occurs during a turbulent separated flow, a reversed tuft should be wiggling rapidly. If it is not, it is probably stuck. A tuft indicating normal flow will not usually wiggle. An occasional application of silicone spray to the tufts, and making sure that they are positioned so that they cannot catch on any seam will minimize the problem of sticking.

TRIMMING YOUR GLIDER IN PITCH

The fore and aft location along the keel of your hang point is commonly (if mistakenly) referred to as your "CG location." The location of this hang point will, all other things being equal, determine at what angle of attack and airspeed your glider will naturally tend to fly (or trim), and therefore how much bar pressure there is to pull in from trim to a given faster speed, or how much pressure there is to push out from trim to a given slower speed. The farther forward your hang point is, the faster the glider will trim, the less effort will be required to fly fast, and the more effort will be required to fly slow. The CG on the Spectrum is adjustable by moving the hang strap fore and aft on the keel. The hang strap is secured in position by a velcro cinch strap. This strap must be very tight to insure that the hang strap is not inadvertently moved fore or aft along the keel during set up or breakdown. To tighten the velcro, grasp the hanging portion hang strap with the left hand and pull down while pushing upwards with your left thumb on the velcro cinch strap where it passes through the top end of the hang strap which loops around the hanging portion. Simultaneously, pull up vigorously on the cinch strap and press it into place against the mating velcro surface.

PLEASE NOTE: We recommend that you not stow your glider bag, or any other cargo on the glider. The practice of putting your glider bag inside the sail, for example, can drastically alter the pitch trim and static balance of your glider, and adversely affect its flying and landing characteristics. The best place to carry your glider bag or other cargo is in your harness.

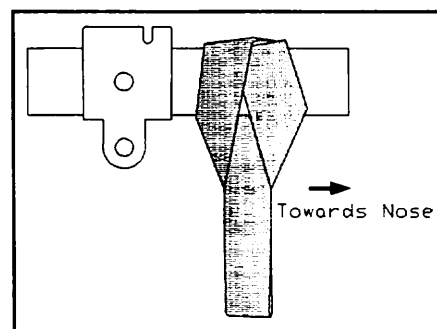

Figure 49 (Cinch strap not shown)

The best way to set your CG is to decide first where you want to trim relative to your minimum sink speed. Some pilots like to trim at minimum sink, (because they don't like to push out all the time in thermals). Other pilots prefer to trim somewhere between minimum sink and best L/D (because they don't like to pull in against heavy bar pressure during long glides at high speed).

Once you have decided where to trim relative to minimum sink speed, use the method above to find minimum sink speed and adjust the hang point location accordingly. Your glider will normally trim properly with the hang loop somewhere between just forward of and 1.5" forward of the control bar apex bracket, depending on your pilot weight. Lighter pilots will need to set the hang loop further aft to achieve the same trim. We recommend that you not trim your glider below MSA.

In the absence of the use of tufts, it has become common for pilots to talk about bar position, or about indicated airspeed, when trying to communicate how to trim a glider properly or how to fly a glider at the proper speed for a given situation. The problem is that these methods are unreliable and inconsistent from one pilot to another even on the same glider. The angle at which your harness suspends your body in your glider has a great deal to do with your perception of the bar "position" relative to your body. Airspeed indicators vary in their indicated airspeed depending on the make of the instrument, its calibration, any installation error, etc. The use of tufts gives you an absolute first hand indication of the actual aerodynamic event associated with two critically important airspeeds on your glider. It is a potentially useful tool that may improve your flying.

LANDING THE SPECTRUM

We recommend using an aircraft landing approach (45 entry leg, downwind leg, base leg, and final leg) whenever possible, and we suggest that you practice making your approaches with as much precision as possible.

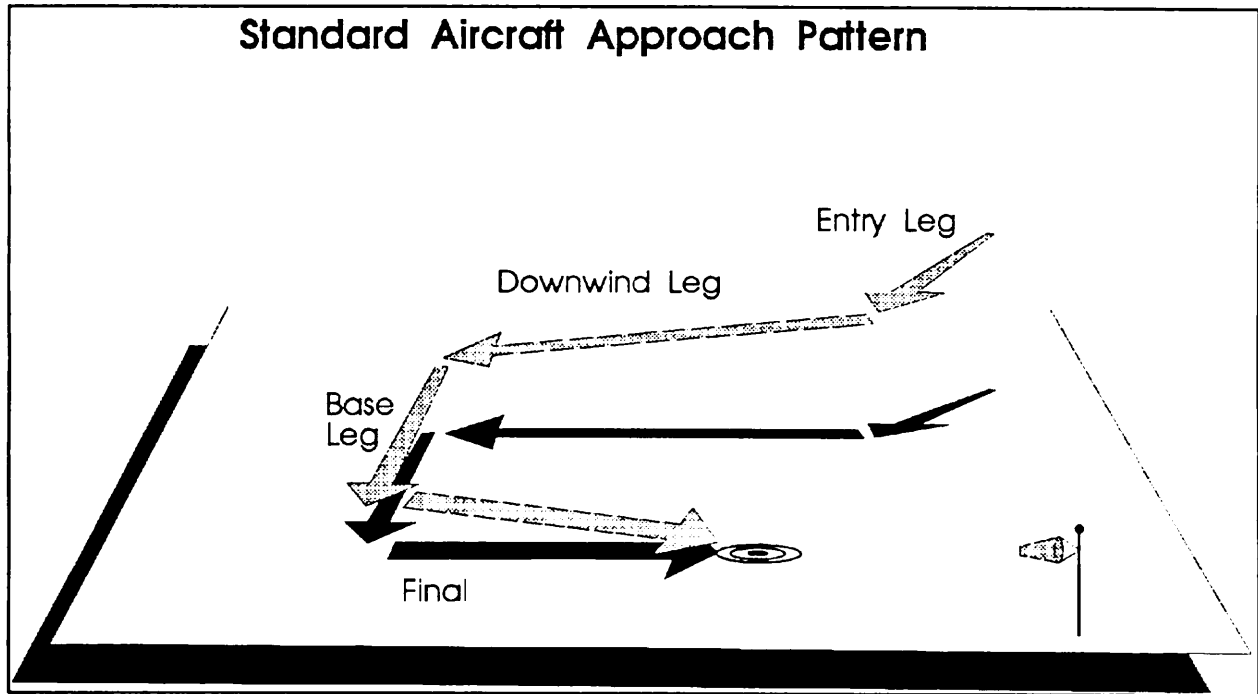

Figure 50

Under ideal conditions, landing approaches are best done so as to include a long straight final into the wind at a speed above best L/D speed. In a very limited field, or a field which slopes slightly downhill, when landing in light wind, you may need to make your final approach at a slower speed, perhaps as slow as minimum sink, in order to be able to land within the field. In winds of less than 5 mph, if the slope is steeper than 12:1, you should seriously consider landing downwind, uphill; or crosswind, across the slope.

Some pilots have difficulty with roll yaw oscillations on final approach on a high performance glider. The best way to avoid this is to fly your entire approach at a constant airspeed, and to control your touchdown point by making adjustments to the shape of your pattern. In particular, you should avoid the technique of make a diving turn onto final. This maneuver, sometimes called a "slipping turn" is often taught to hang glider pilots as a way to lose altitude during the approach. It works reasonably well with low performance low aspect ratio gliders which have high levels drag, yaw stability and damping, and which are able to lose energy by diving because of the large increase in drag at higher speeds. On a high performance glider, this technique serves only to convert the energy of altitude to energy of speed, while at the same time suddenly increasing the glider's sensitivity to control inputs. The result is a high probability of overshooting the intended landing point and the prospect of roll / yaw oscillations which may interfere with a proper landing.

On final approach, fly the glider down to within just a few feet of the ground, and bleed off excess speed in ground effect while keeping the wings level and the nose into the wind. Your body position should be inclined with your head and shoulders forward and your feet and legs trailing behind, with your hands at shoulder width and shoulder height on the uprights. As the glider begins to settle in a mush, and before you have extended your arms significantly, give a sharp aggressive flare pushing your arms and shoulders forward and your hips, legs and feet backwards. The braking effect of the flare will allow your feet to swing under you as the glider's forward motion is arrested. (Figure 51, 52)

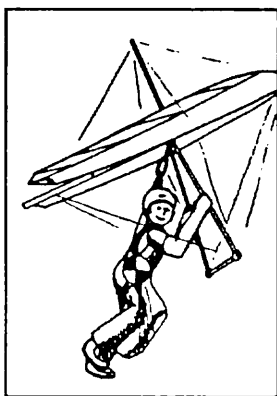

Figure 51

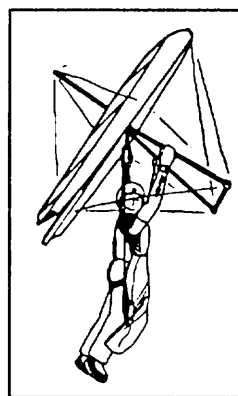

Figure 52

Note: Landing in a significant wind does not require a substantial landing flare; the pilot merely slows to near zero ground speed and touches down. The proper flare in light or no wind conditions is a dynamic action which causes a sudden and severe pitch up rotation of the glider. Pilots who have trouble with the flare, and with the glider nosing over during landing, usually do so because of one of the following problems:

a) Harness leg straps too long / hanging too low below the glider, and / or hands too low on the control bar. This reduces pitch authority and prevents an adequate flare. (Figure 53)

b) Improper body position - pilot leaning back, (away from the anticipated hard landing), with feet extended in front. (Figure 54) This moves the pilot's center of mass forward ahead of his shoulders, effectively shortening the pilot's arms and reducing flare authority. The proper position is with the pilot's body inclined forward, with the shoulders out ahead of the pilot's center of mass. Thinking about pushing "up" instead of "out" when flaring may help you to maintain the proper forward inclined body position.

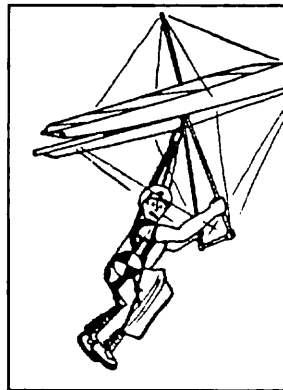

Figure 53

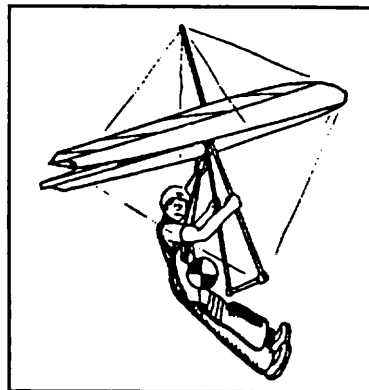

Figure 54

c) Waiting too long to flare. It is possible to fly the glider into a mush on the final approach, and reach a point where your arms are extended to the point where you have insufficient reach left with which to flare. It is far better to flare a little early in this situation and climb a few feet before touching down than to flare late and land with high forward speed.

SPECTRUM BREAKDOWN

Breakdown is the exact reverse of assembly.

- 1) Remove the nose cone and pull the nose batten out two inches past the noseplate.
- 2) Detach the bottom nose wires by pulling down on the nose of the glider while pushing upwards on the plastic tang handle on the keyhole tang. (Figure 55)
- 3) Before you de-tension the crossbar, remove the plastic wing tips, and the number one battens, and remove the first three (outboard most) cambered battens on each side. Roll up the sail at the wingtip and slide on the wingtip cover bag. Place the plastic wingtip fairings in the wingtip cover bags and secure the velcro tab on the bag. (Figure 56)

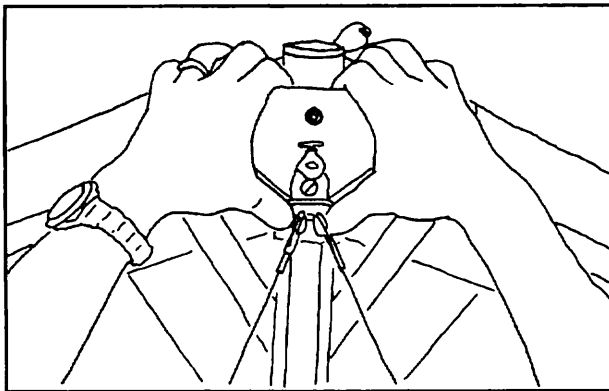

Figure 55

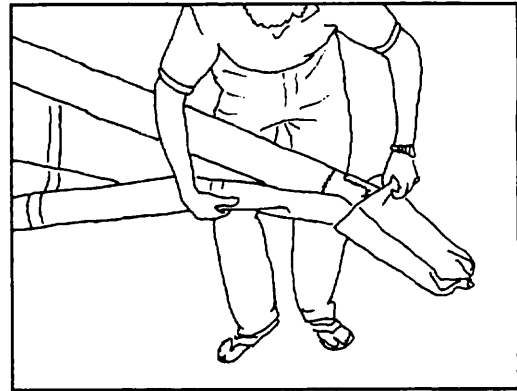

Figure 56

- 4) At the control bar apex, remove the safety and wingnut from the crossbar restraint cable. Use the perlon as you did during set up to pull the crossbar back and take the load off the crossbar cable, and pull the bolt out of the keel. Replace the other side cable thimble, the wingnut and the safety on the bolt. (Figure 57)

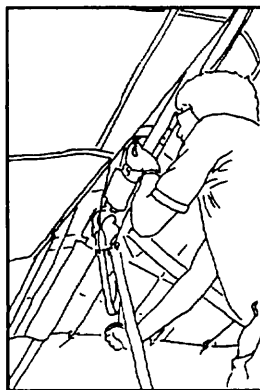

Figure 57

Release the perlon and allow the crossbar to slide forward, de-tensioning the sail.

Unstow the apex protector pads from inside the double surface (if so equipped) and install them around the tops of the control bar legs. Secure the velcro tabs. (Figure 58)

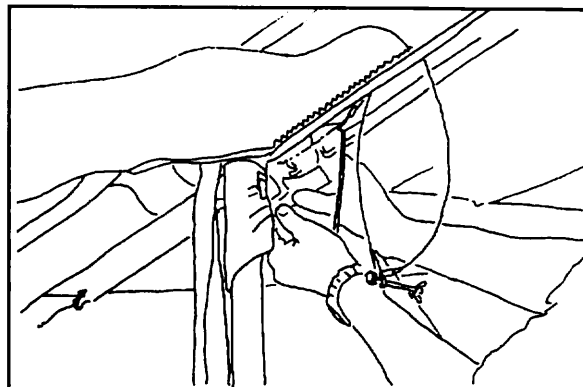

Figure 58

5) Fold the wings in about 1/4 of the way. Remove all the remaining battens, (except the nose batten) including the bottom surface battens. Place the cambered battens in the batten bag.

7) Detach the top rear wire at the rear keel. Detach the bridle ring from the bridle snap clip. Loop the top rear wire around the bridle cables and pass the keyhole tang through the elastic webbing band at the top of the kingpost top cover. (Figure 59)

Remove the kingpost from the kingpost base. Install the kingpost top protector over the top of the kingpost. (Figure 60)

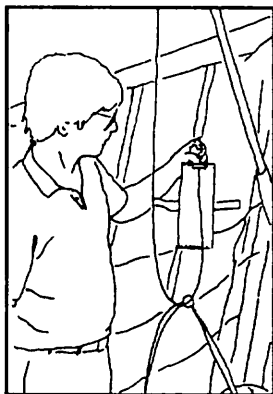

Figure 59

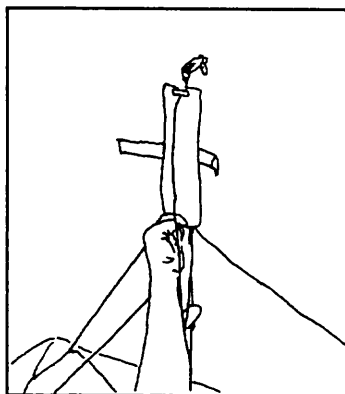

Figure 60

8) Lay the kingpost down on top of the sail along the keel, and attach the velcro on the kingpost top protector to the nose cone velcro on the sail to hold the kingpost in position. (Figure 61)

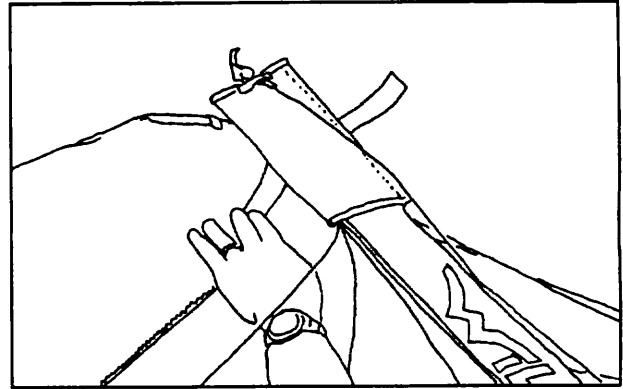

Figure 61

9) Fold the wings in the rest of the way and pull the sail over the top of the leading edges. Roll the straight battens and the washout tips in the sail, and tie the sail with the velcros provided. We recommend that you roll and tie each side of the sail separately. (Figure 62, 63)

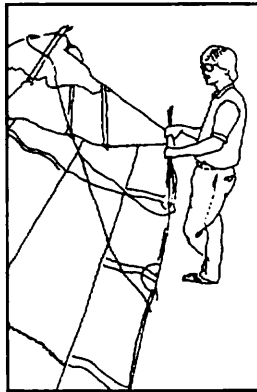

Figure 62

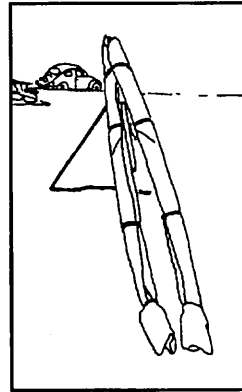

Figure 63

10) Put the bag on the glider, flip it over and lay it down.

11) Detach the upright from the basetube, and fold up the control bar. Put the cover bag on the control bar and pull it all the way forward. (Figure 64)

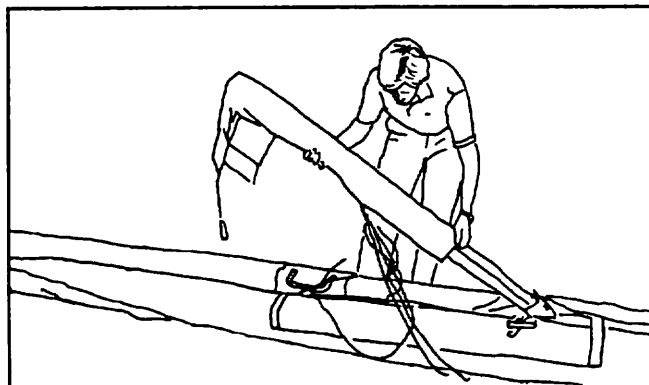

Figure 64

12) Slide the protective pad on the control bar bag under and around the keel tube at the rear wire bolt. Install the keel end protector cover. (Figure 65, 66)

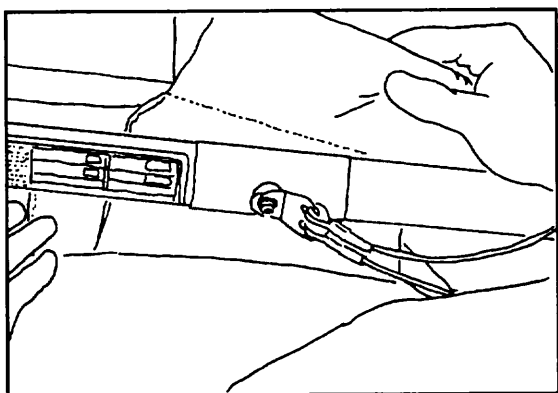

Figure 65

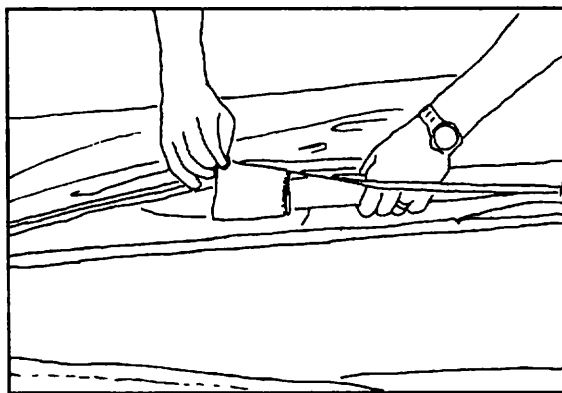

Figure 66

13) Put the batten bag on the battens. Stow the battens between the rear leading edges. Stow the nosecone under the forward velcro sail tie. (Figure 67, 68) Zip up the bag.

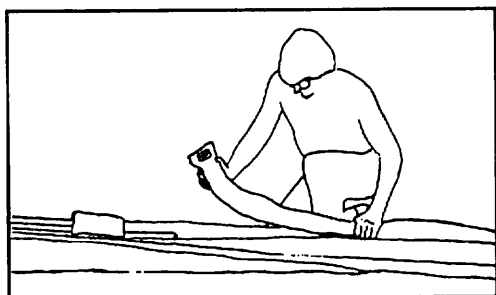

Figure 67

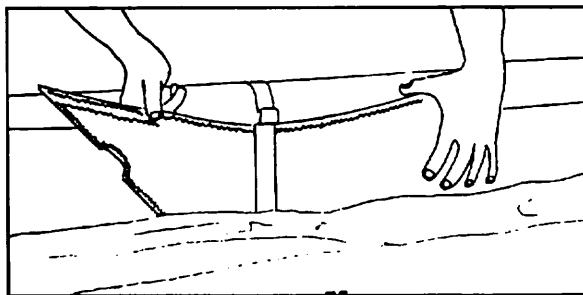

Figure 68

SPECTRUM STABILITY SYSTEMS

Stability in pitch is provided by reflex in the root section, which is determined by the lengths of the kingpost, control bar, and front to rear top and bottom wires, by reflex support bridles running from the kingpost to the trailing edge at the number 4 and 6 battens. Correct attachment and proper adjustment of the bridles are critical to providing adequate stability at low angles of attack, particularly those below the normal operating range.

REFLEX BRIDLE ADJUSTMENT

As a starting point to adjusting the bridles, the bridles should be set so that a tape measure hooked over the top front wire at the kingpost cap and extended to the intersection of the batten pocket seamed edge and the sail trailing edge measures as follows:

Bridle Checking Specs

Spectrum 165:	Inner: 91.25"	Outer: 146.75"
Spectrum 144:	Inner: 80.875"	Outer: 128.875"

The bridles are adjusted when necessary by changing the bridle pigtail for one of a different length. The glider must be fully assembled to measure the bridles.

Following the initial adjustment of the bridles to these measurements, the glider must be flown, and the shadow of the bridles sighted against the sail. The bridles are correctly adjusted when they are "just slack" in flight; i.e. as tight as they can be, without actually being tight in flight in normal one G flight. Normally, the outboard bridles will have slightly more slack than the inboards. Overly tight bridles will adversely affect the glider's handling, especially in turbulent air.



MAINTENANCE SCHEDULE:

You should continually maintain your glider in a proper state of tune and repair to insure optimum airworthiness, performance and flight characteristics. Failure to properly maintain your glider may lead to a dangerous loss of strength, stability or control responsiveness of the glider. Following any mishap that results in damage to the glider immediately have any damaged component repaired or replaced. We recommend that you have all such maintenance work done by your Wills Wing dealer. In addition, please follow the following maintenance schedule:

EVERY MONTH:

- 1) Spray all zippers on the glider with silicone spray lubricant. Also spray your battens as you install them in the glider to lubricate the insides of the batten pockets. Do not use any other type of lubricant. Wipe off any excess silicone so that it does not attract dirt. If you fly in a dusty or sandy environment, it will help to prolong the life of your batten pockets if you wipe each batten with a rag before you install it in the sail.
- 2) Check your battens on a flat level floor against the batten diagram provided, and correct any that deviate from the pattern by more than 1/4".

EVERY SIX MONTHS:

- 1) Have a complete inspection performed on the glider and replace any suspension system component that shows any wear, and any cable that shows any kinks, wear, damage, corrosion, etc.
- 2) Inspect all bolts for tightness, all safeties for proper installation and possible damage. Inspect plates and fittings for damage, holes in tubes for elongation.
- 3) Inspect the sail for wear, tears, UV damage, loose stitching, etc.

EVERY YEAR:

- 1) Have the sail completely removed from the frame, and disassemble all frame components. Inspect every part of the glider for any damage or wear. Inspect the tubes for straightness and for signs of corrosion. Anytime you have the sail off the frame, turn the sail inside out through the bottom surface center zipper and inspect all of the batten pockets and batten pocket terminations.
- 2) Replace bottom side wires and hang loops.

SPECIAL CIRCUMSTANCES

- 1) Any time you suffer a crash or extremely hard landing you should have an "annual" inspection done on your glider to insure that you find all damaged parts.
- 2) If your glider is ever exposed to salt water you will need to have the glider completely disassembled in accordance with the recommended annual inspection procedure. All frame parts will need to be disassembled, including the removal of all sleeves, flushed liberally with fresh water, dried completely, and treated for corrosion inhibition with LPS-3 or other suitable agent.
- 3) Cleaning Your Sail - Keeping your sail clean will extend the life of the cloth. When cleaning the entire sail you should generally use only water and a soft brush. You may clean small spots or stains with any commercial spot remover that is labeled for use on polyester. Such cleaning agents are available at the supermarket or drug store, or you may order a cleaning solution from Wills Wing through your dealer.

REMOVING THE SAIL FROM THE AIRFRAME AND RE-INSTALLING

Many maintenance and repair procedures will require the removal of the sail from the frame. Please follow these instructions when removing and re-installing the sail. Please read all the instructions for each operation before beginning.

SAIL REMOVAL

You will need an unobstructed area six feet by thirty feet. Make sure the surface is clean. If it is abrasive, like rough concrete, you should either put down a protective tarp or be extremely careful not to scrape your sail.

- 1) Lay the glider on its back, unzip and remove the glider bag and put the battens aside. Remove the control bar bag.
- 2) Cut or untie the string sail mount at the nose. Spread the wings slightly, undo the velcro tabs inside the rear ends of the leading edges and then dismount the sail from the rear leading edges. Tape the sail plugs in position on the leading edges so that they do not become switched side to side inadvertently.
- 3) Undo the velcro which holds the front part of the keel pocket together. Unbolt the bottom side wires from the control bar. Unbolt the control bar top elbows at the control bar apex from the CG bracket on the keel. Unbolt the bottom rear flying wires from the rear keel. Re-assemble the hardware removed onto the bolts in the original order so that it doesn't get lost. All disassembled assemblies on the glider must be re-assembled in the proper order and orientation. Use the exploded parts diagrams in this manual to help you. On the bottom rear wire, the relative position of the washers, saddles and tangs affects the front to rear wire tension. Set the control bar aside.

5) Turn the glider over. Unroll the sail until you can reach the bridle attachments at the trailing edge. Remove the plastic bridle retainer balls and disconnect the bridles from the sail.

6) Remove the screw that holds the kingpost top cap in place and carefully remove the cap. Remove the top front and top side wires from the kingpost top. Re-install the cap. Set the kingpost aside.

7) Disconnect the sail from the keel at the rear of the keel pocket.

8) Feed the top and bottom side wires into the sail through the holes in the sail. Turn the glider over onto its back again. Slide the frame back far enough from the nose to enable you to slide the sail out through the bottom surface zipper opening. If you encounter resistance, stop and find out what is hanging up.

9) If you need to send the sail into the factory for repair, remove the mylar. It usually slides out the front of the pocket without undue difficulty. It helps to secure the rear end of the sail to something solid, so that you can lay the leading edge out straight and pull the mylar straight out of the pocket. If you have trouble getting it to slide out freely, it is probably because the edge of the mylar has worked its way into the seam and gotten stuck on the adhesive seamstick tape. Work your way up and down the leading edge pocket rolling the mylar away from the seam until it is free along its entire length. Fold and package the sail carefully if you plan to ship it in for repair. Be sure to include written instructions of what you want done, your name and a phone number where you can be reached during the day.

RE-INSTALLING THE SAIL ON THE FRAME

1) Install the mylar in the sail. (If the mylar pockets have been replaced you will need to trim the mylar by 1/2". Also, the sail will probably need to be mounted looser.) Make sure you install it right side up; the curved edge is at the front and on the bottom. The easiest way to install the mylar is to push it into the pocket using a long lofting batten attached to the rear end of the mylar insert. A small diameter pin on the end of the lofting batten placed through a small hole in the aft end of the mylar insert allows you to push the mylar into the sail and remove the batten while leaving the mylar in place. You will have to stop from time to time to make sure the mylar is properly lying flat in the pocket. Do not push the mylar too far into the pocket; stop when the top side wire hole in the mylar lines up with the hole in the sail.

2) Position the sail on the floor with the keel pocket up and the wings folded over so that the leading edges lie along the length of the root line, with the mylar pockets lying on top.

3) Prepare the frame, making sure that the side wires are pulled forward from the crossbar leading edge junction and are not wrapped around the frame.

4) Position the frame with the bottom of the noseplate facing up and with the rear end of the leading edges at the nose of the sail. Slide the frame in through the open bottom surface center zipper, making sure that the leading edges of the frame pass properly into

the leading edge pockets of the sail and don't get caught at the rear of the bottom surface near the root. As you feed the frame slowly into the sail, check periodically to see that none of the hardware is snagging on the sail.

- 5) When the rear end of the keel reaches the keel pocket, slide the keel into the keel pocket.
- 6) When the noseplate passes the nose of the sail, insert the nose of the frame back forwards into the nose of the sail.
- 7) After the frame is fully installed, mount the webbing anchor loops over the rear leading edge endcaps. **Make sure you mount the inner webbing loops in the endcap slots, not the outer "handle" loops!** Make sure that the webbing lies flat and smooth in the slot, and that the sail is properly aligned when mounted. Secure the velcro retainer tabs. Install the nose string sail restraint as tight as you can at this time; you will need to tighten it later after the glider is set up.
- 8) Working through the camera mount zippers, insert the top and bottom side wires through the holes in the sail, making sure that no cable is wrapped around a leading edge or crossbar, and that no thimbles are cocked or twisted.
- 9) Bolt the bottom rear wires to the rear of the keel. Install the control bar onto the keel center bracket, and attach the bottom side wires to the control bar corners.
- 10) Flip the glider up onto the control bar. Working through the center bottom surface zipper, insert the top front wire up through the hole in the sail.
- 11) Re-install all the top wires onto the kingpost.
- 12) Spread the wings slowly and carefully, making sure that the sail rides forward as necessary at the nose without catching. **Be careful: you can easily tear the sail open at the nose at this point.**
- 13) Set the kingpost on the keel center bracket. Connect the top rear wire, and the bottom front wires. Connect the bridles to the sail.
- 15) Re-attach the rear keel pocket sail mount to the keel.
- 16) Finish the assembly of the glider completely according to normal assembly procedures.
- 17) Re-adjust the nose sail mount string so that it is slightly slack. Do a very careful and complete pre-flight of the glider according to the normal pre-flight procedure as explained earlier in this manual.

TUNING

DISMOUNTING AND RE-MOUNTING THE SAIL AT THE TIP

A number of tuning procedures require you to dismount the sail at the rear leading edge. This can be most easily accomplished by using a large, flat bladed screw driver to pry the sail mount webbing off of the end of the leading edge. The same technique can be used to re-install the sail. Take care not to damage the sail mount webbing, and when re-mounting the sail, be sure to mount the inner webbing in the slot, not the outer handle webbing, and be sure that the webbing seats squarely in the slot.

CG ADJUSTMENT has already been covered in the section of this manual on using your wing tufts. Wills Wing recommends that tuning other than CG adjustment be performed by your Wills Wing dealer.

TURN TRIM

Turns are caused by an asymmetry in the glider. If you have a turn, first try to make the glider symmetrical in every way.

AIRFRAME

Check the leading edges for possible bent tubes. Check that the keel is not bent to one side.

BATTENS

Check the battens for symmetrical shape and batten string tension.

SAIL TENSION

Check for symmetrical sail tension on the leading edges (sight the hem of the sail at the bottom of the leading edge tube relative to the noseplate on each side). Sail tension is adjusted by adding or removing shims in 1/8" or 1/4" increments from inside the sail mount plugs on the rear ends of the leading edges.

SAIL PLUG ROTATIONAL ALIGNMENT

Check for symmetry in the alignment of the sail mount at the tips.

After you have made everything symmetrical, if you still have a turn, remove the sail mount plug from the wing away from which the glider is turning. Drill out the pop rivet that secures the slotted endcap in the plug, and twist the plug one rivet hole diameter in such a direction so as to raise the trailing edge of the sail on that wing. Install a new rivet and re-install the plug in the leading edge, and the sail onto the plug. If the sail is already twisted up at the tips such that the bottom surface at the tip does not go tight in flight, then you will need to twist down instead of up, and to twist that wingtip towards which the glider is turning.

ADJUSTING BATTEN TENSION

All battens are tensioned by looping the batten string over the notched end of the batten twice. The inboard batten strings should be slightly on the loose side, (just tight enough to pull most of the static wrinkles out of the sail as you put the batten string on) and the outboard batten strings should be progressively tighter. The number one batten strings should be quite tight, and when they are properly adjusted you will not be able to install them unless the crossbar is tensioned. The batten string tension must be symmetrical from side to side.

LEADING EDGE SAIL TENSION

The tension in the leading edge of the sail, adjustable by shimming as described above, will influence the performance and handling of the glider. If the sail is mounted too loose, the performance will deteriorate noticeably. If the sail is mounted too tight, the glider will handle poorly; it will be stiff and slow in roll response with excessive adverse yaw. As the glider gets older and the sail stretches, you will need to add shims to maintain the proper tension.

CAR TOP MOUNTING AND TRANSPORT

Improper or careless transport of your glider can cause significant damage. You should transport your glider on a rack which has at least three support points which span at least 13' of the length of the glider. These should be well padded and at least four inches wide to distribute the load. Your glider should be mounted on your rack with the control bar facing up. It should be securely tied down with webbing straps which are at least 1/2" wide, but not tied so tightly or with such a small diameter rope that the mylar insert is permanently deformed. If you drive on rough roads where the glider receives impact loads, you should take extra care to pad your glider internally when you pack it up. One special area to pay attention to is the crossbar center section, where it bears against the top of the leading edge tubes. Some extra padding inserted in this area will save wear on your airframe and sail.

IN CLOSING

With proper care and maintenance, your glider will retain a high level of airworthiness for some years. Because of the relatively short history of hang gliding, and the rapid advances in new designs, we do not have a lot of information about the ultimate service life of a hang glider. We do know that ultraviolet (UV) damage to the sail from sunlight is probably the limiting factor in the life of your sail. Try to avoid exposing your sail to sunlight any time you are not actually flying it.

We also know that there are forces in nature which can be so violent that they can result in fatal accidents regardless of the airworthiness of your aircraft. Ultimately your safety is your responsibility. Know the limitations of your knowledge, skill and experience, and know the limitations of your aircraft. Fly within those limitations.

Have fun. See you in the sky!

Wills Wing, Inc.

HGMA COMPLIANCE VERIFICATION SPECIFICATION SHEET

GLIDER MODEL Spectrum 165
MANUFACTURED BY Wills Wing Inc.

All dimensions in inches; weights in pounds.

NOTE: These specifications are intended only as a guideline for determining whether a given glider is a certified model and whether it is in the certified configuration. Be aware, however, that no set of specifications, however detailed, can guarantee the ability to determine whether a glider is the same model, or is in the same configuration as was certified, or has those performance, stability, and structural characteristics required by the certification standards. An owner's manual is required to be delivered with each HGMA certified glider, and it is required that it contain additional airworthiness information.

- 1) Weight of glider with all essential parts and without coverbags and non-essential parts: 61
- 2) Leading Edge Dimensions
 - a) Nose plate anchor hole to:
 - 1) Crossbar attachment hole 131
 - 2) Rear sail attachment point 232 -233.5
 - b) Outside diameter at:
 - 1) Nose 2.05
 - 2) Crossbar 2.05
 - 3) Rear sail attachment point 2.05
- 3) Crossbar Dimensions
 - a) Overall pin to pin length from leading edge attachment point to hinge bolt at glider centerline 119.25
 - b) Largest outside diameter 2.44
- 4) Keel dimensions; least and greatest allowable distances, whether variable through tuning or through in-flight variable geometry, from the line joining the leading edge nose bolts to:
 - a) The xbar center load bearing pin 40 +/- .5
 - b) The pilot hang loop 58 - 61
- 5) Sail Dimensions
 - a) Chord lengths at
 - 1) 3 ft outboard of centerline 73.75
 - 2) 3 ft inboard of tip 43
 - b) Span (extreme tip to tip) 408.5 (With wingtip fairings)
- 6) Location of Information Placard keel
Location of Test Fly Sticker keel
- 7) Recommended Pilot Weight Range 140 - 240
- 8) Recommended Pilot Proficiency USHGA Novice (II)

NOTE: Stability in pitch is provided by reflex in the root section, which is determined by the lengths of the kingpost, control bar, and front to rear top and bottom wires; and by reflex support bridles running from the kingpost to the trailing edge at the number four and six battens. Proper adjustment of these bridles is critical to the safety of the glider and is described elsewhere in this manual.

HGMA COMPLIANCE VERIFICATION SPECIFICATION SHEET

GLIDER MODEL Spectrum 144
MANUFACTURED BY Wills Wing Inc.

All dimensions in inches; weights in pounds.

NOTE: These specifications are intended only as a guideline for determining whether a given glider is a certified model and whether it is in the certified configuration. Be aware, however, that no set of specifications, however detailed, can guarantee the ability to determine whether a glider is the same model, or is in the same configuration as was certified, or has those performance, stability, and structural characteristics required by the certification standards. An owner's manual is required to be delivered with each HGMA certified glider, and it is required that it contain additional airworthiness information.

- 1) Weight of glider with all essential parts and without coverbags and non-essential parts: 54-56
- 2) Leading Edge Dimensions
 - a) Nose plate anchor hole to:
 - 1) Crossbar attachment hole 117
 - 2) Rear sail attachment point 210.5 -212
 - b) Outside diameter at:
 - 1) Nose 2.05
 - 2) Crossbar 2.05
 - 3) Rear sail attachment point 2.05
- 3) Crossbar Dimensions
 - a) Overall pin to pin length from leading edge attachment point to hinge bolt at glider centerline 106.8
 - b) Largest outside diameter 2.44
- 4) Keel dimensions; least and greatest allowable distances, whether variable through tuning or through in-flight variable geometry, from the line joining the leading edge nose bolts to:
 - a) The xbar center load bearing pin 35.75 +/- .5
 - b) The pilot hang loop 56.5 - 59
- 5) Sail Dimensions
 - a) Chord lengths at
 - 1) 3 ft outboard of centerline 72
 - 2) 3 ft inboard of tip 42
 - b) Span (extreme tip to tip) 373 (With wingtip fairings)
- 6) Location of Information Placard keel
Location of Test Fly Sticker keel
- 7) Recommended Pilot Weight Range 120 - 210
- 8) Recommended Pilot Proficiency USHGA Novice (II)

NOTE: Stability in pitch is provided by reflex in the root section, which is determined by the lengths of the kingpost, control bar, and front to rear top and bottom wires; and by reflex support bridles running from the kingpost to the trailing edge at the number four and six battens. Proper adjustment of these bridles is critical to the safety of the glider and is described elsewhere in this manual.

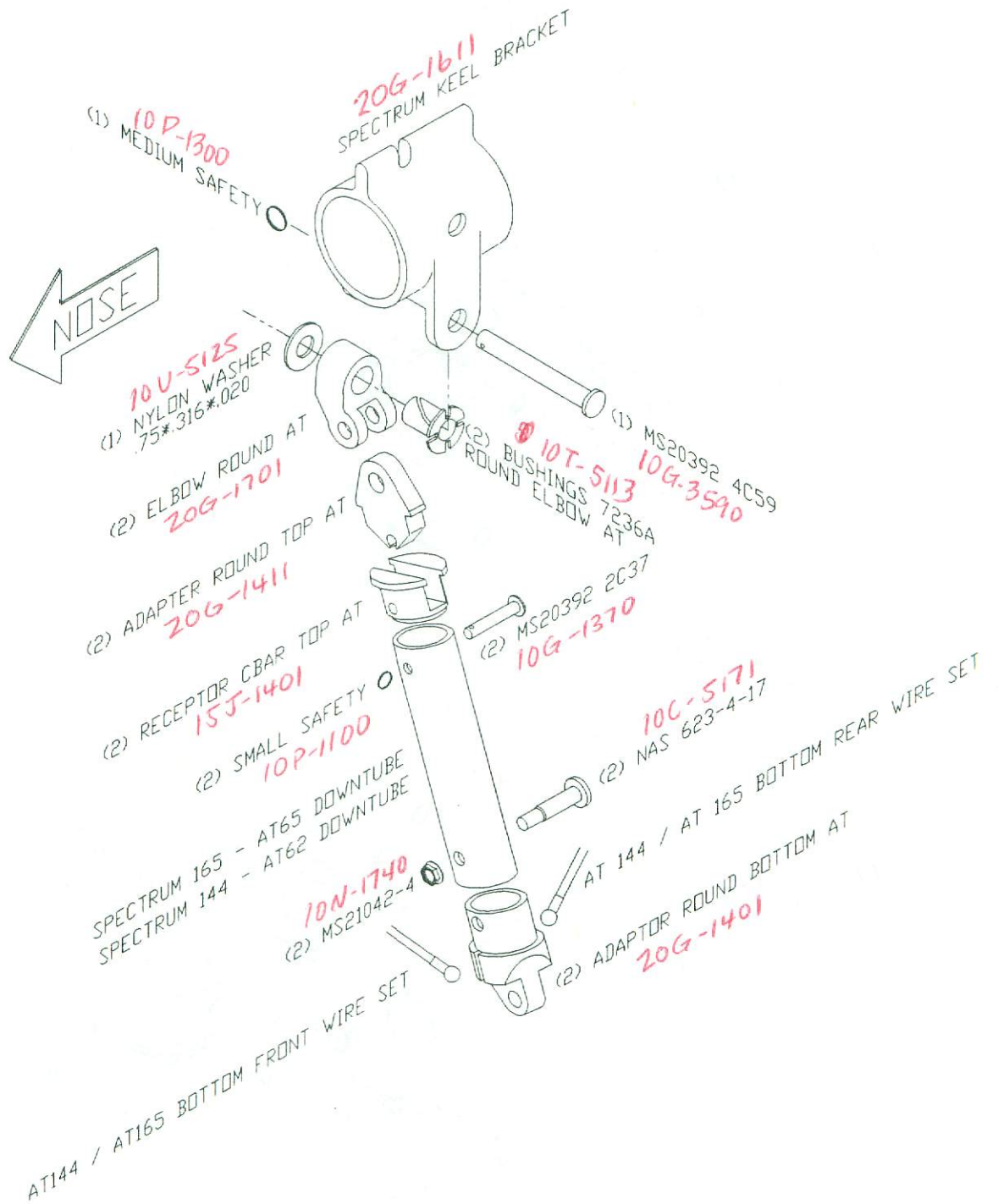

SPECTRUM ROUND CONTROL BAR ASSEMBLY

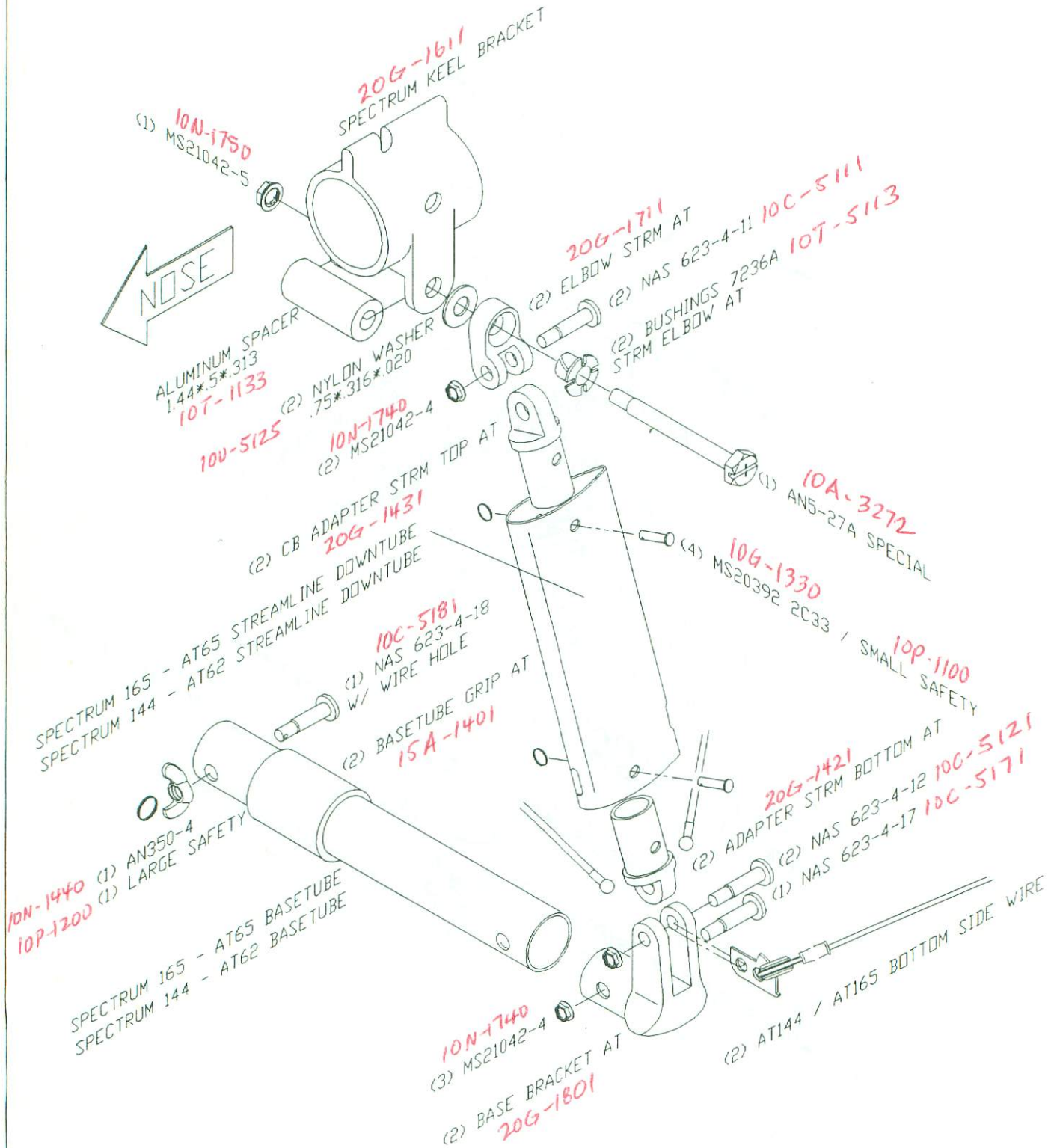

SPECTRUM STREAMLINE CONTROL BAR ASSEMBLY

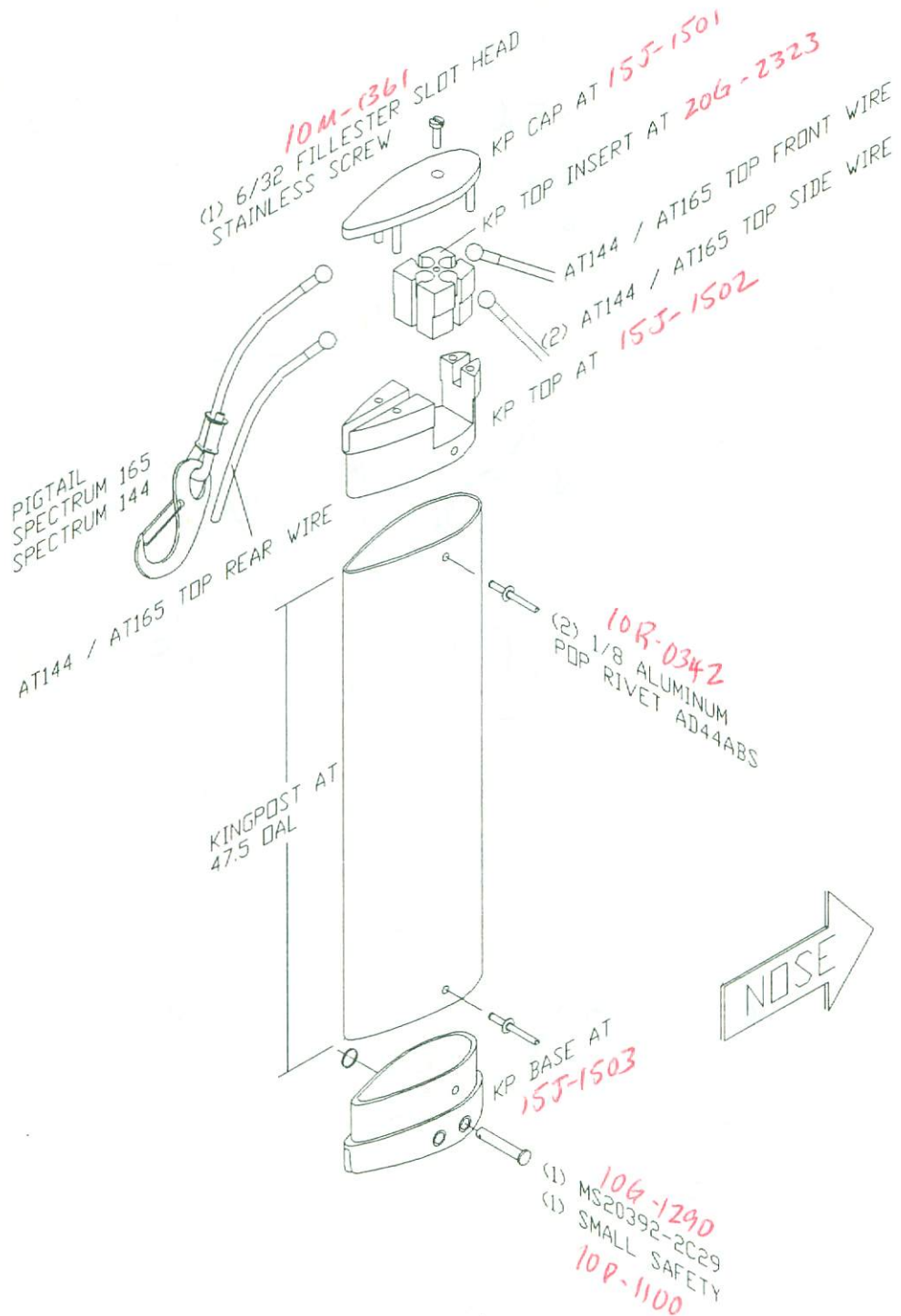

SPECTRUM KINGPOST ASSEMBLY

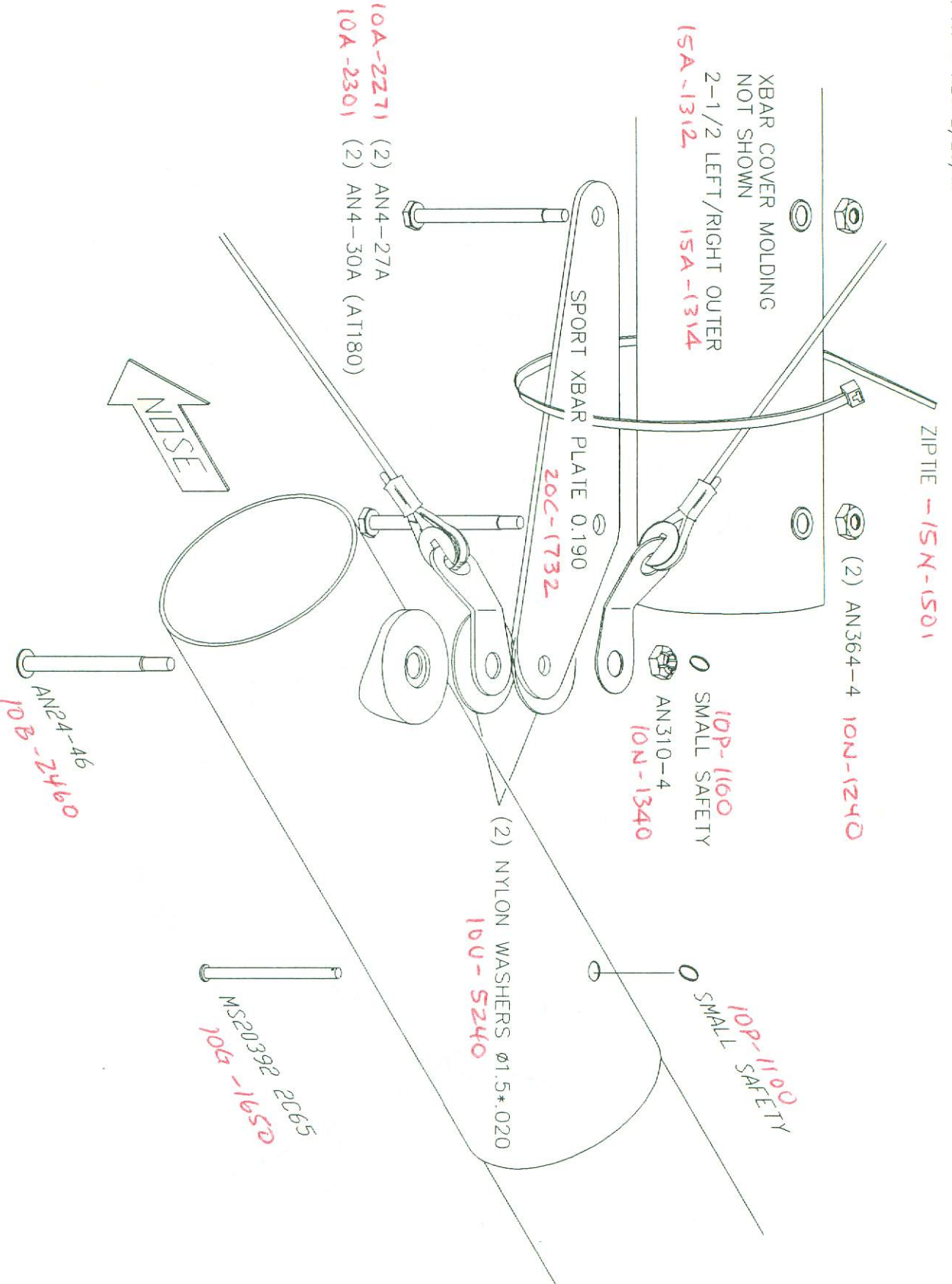

SPECTRUM / SPORT AT CROSSBAR - LEADING EDGE ASSEMBLY

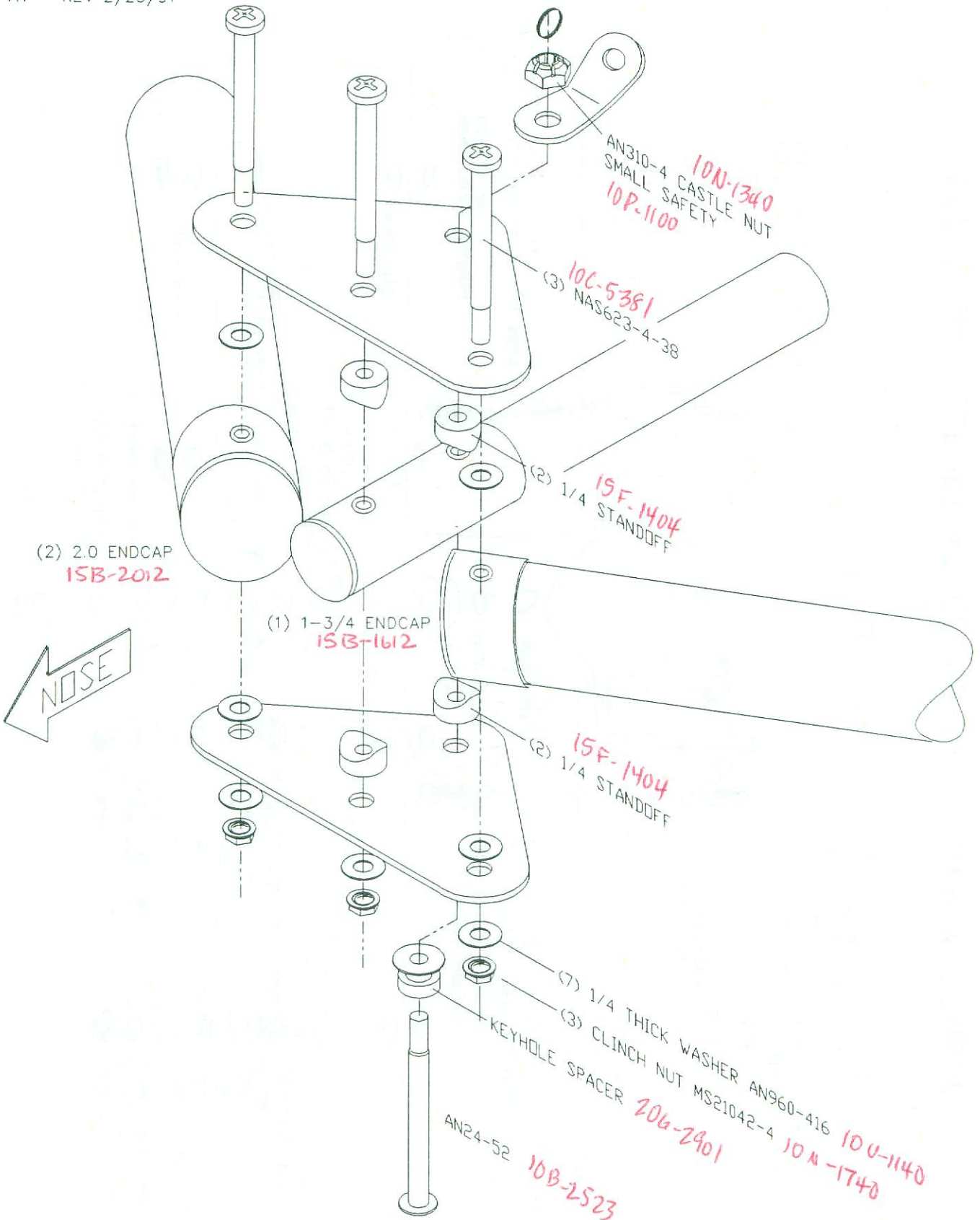

SPECTRUM / SPORT AT NOSEPLATE ASSEMBLY

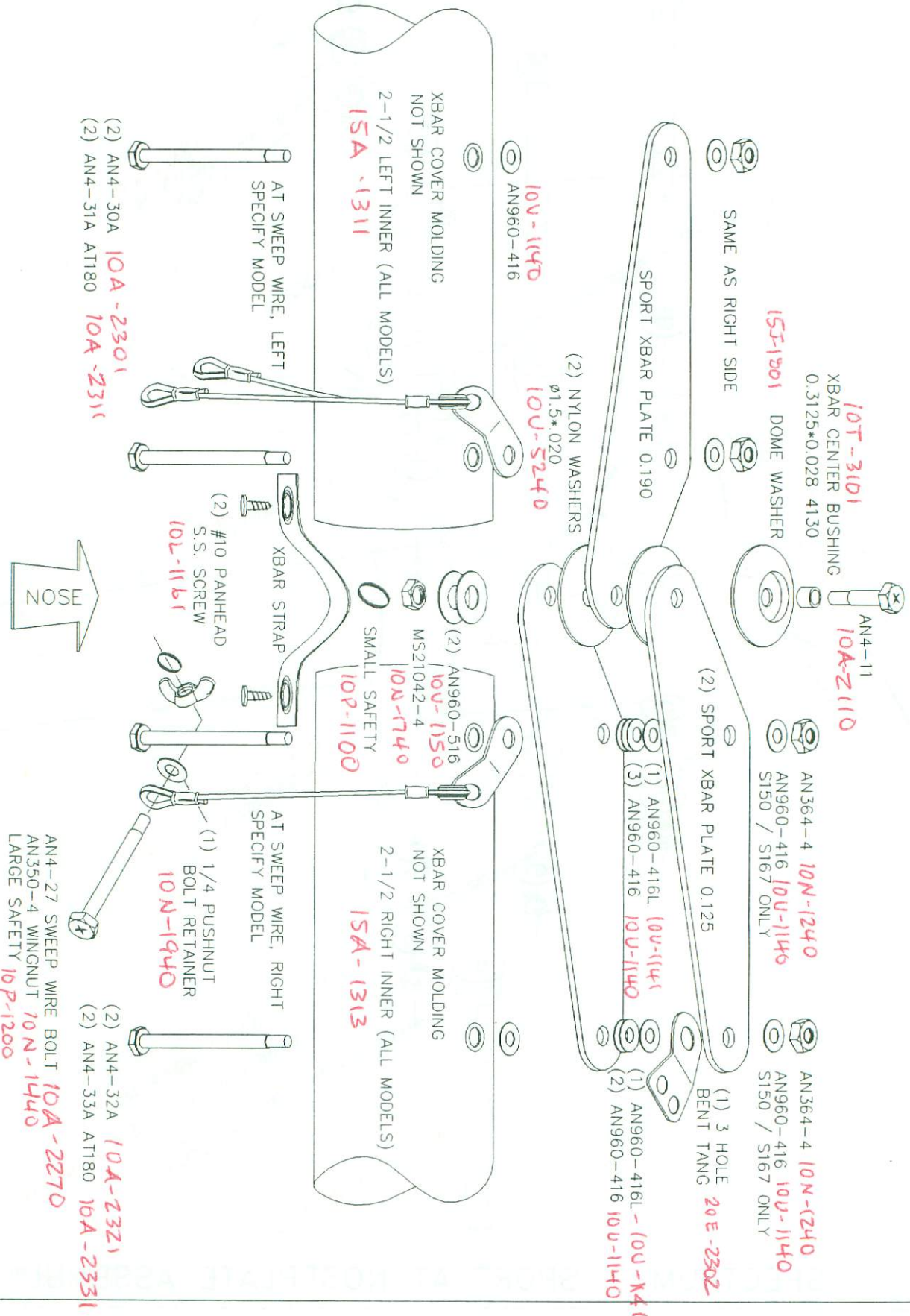

SPECTRUM / SPORT AT CROSSBAR CENTER ASSEMBLY

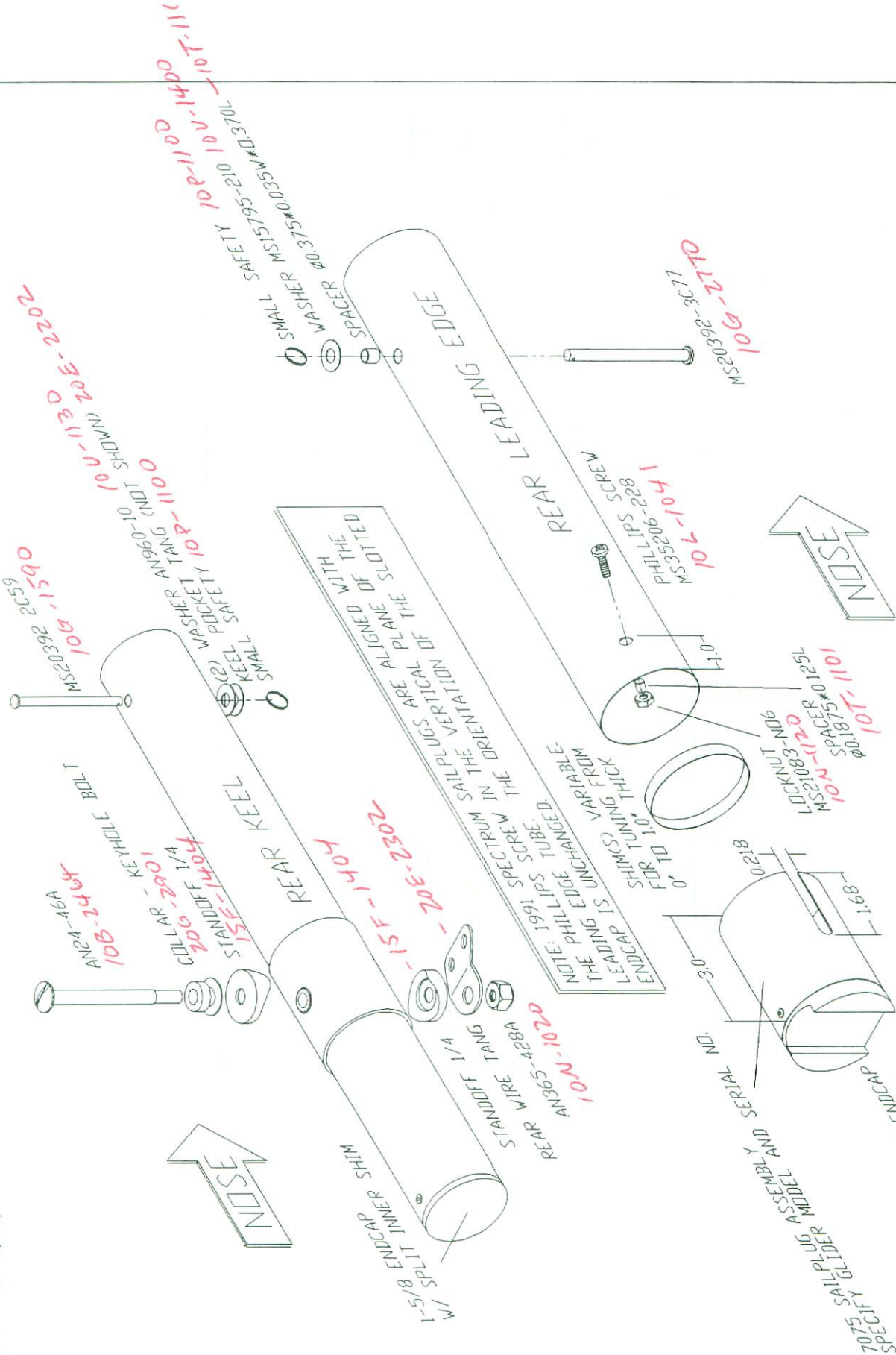

SPECTRUM MISCELLANEOUS ASSEMBLIES

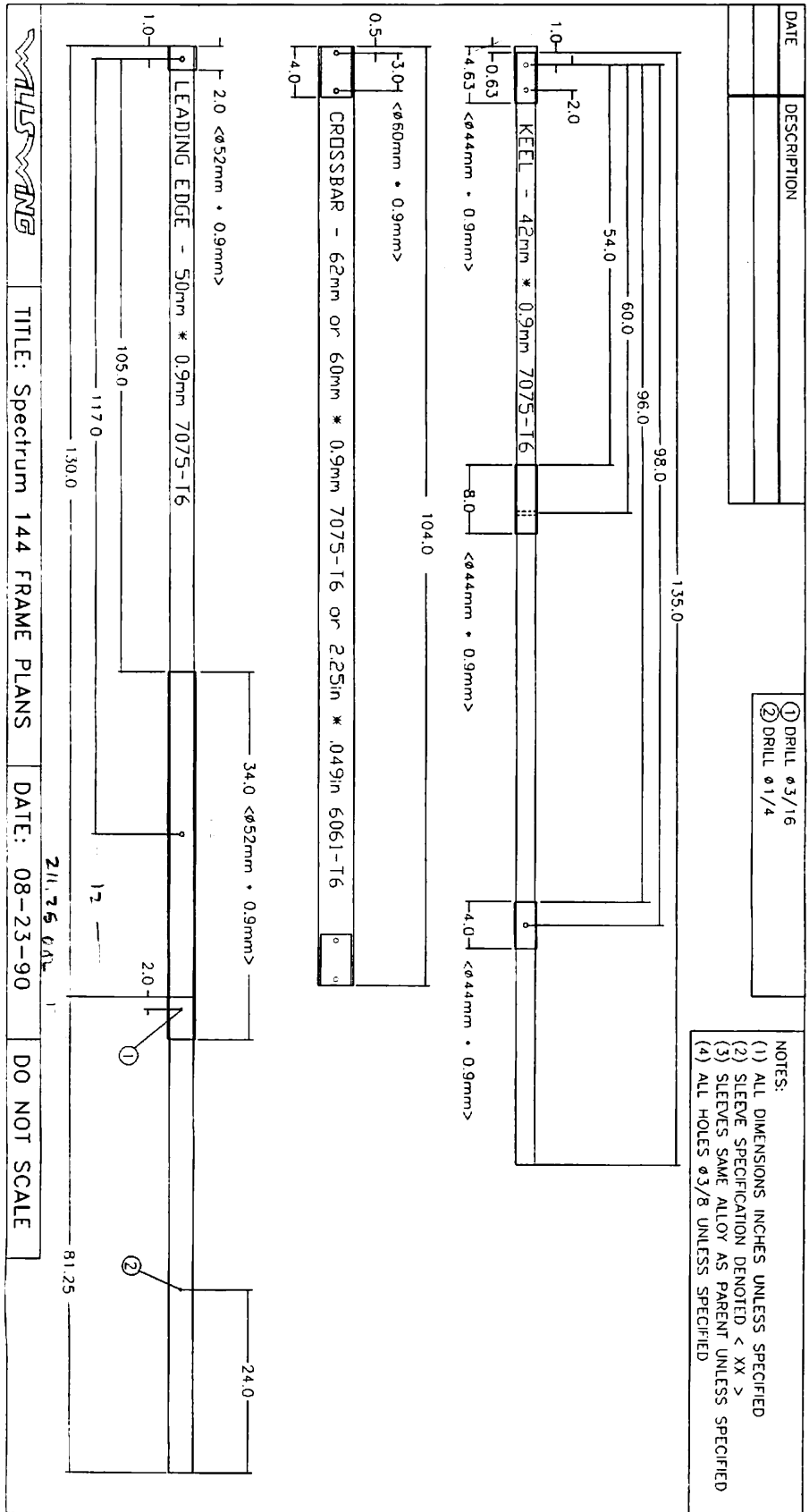

WILSON

TITLE: Spectrum 144 FRAME PLANS

DATE: 08-23-90

DO NOT SCALE

211.75 DATE

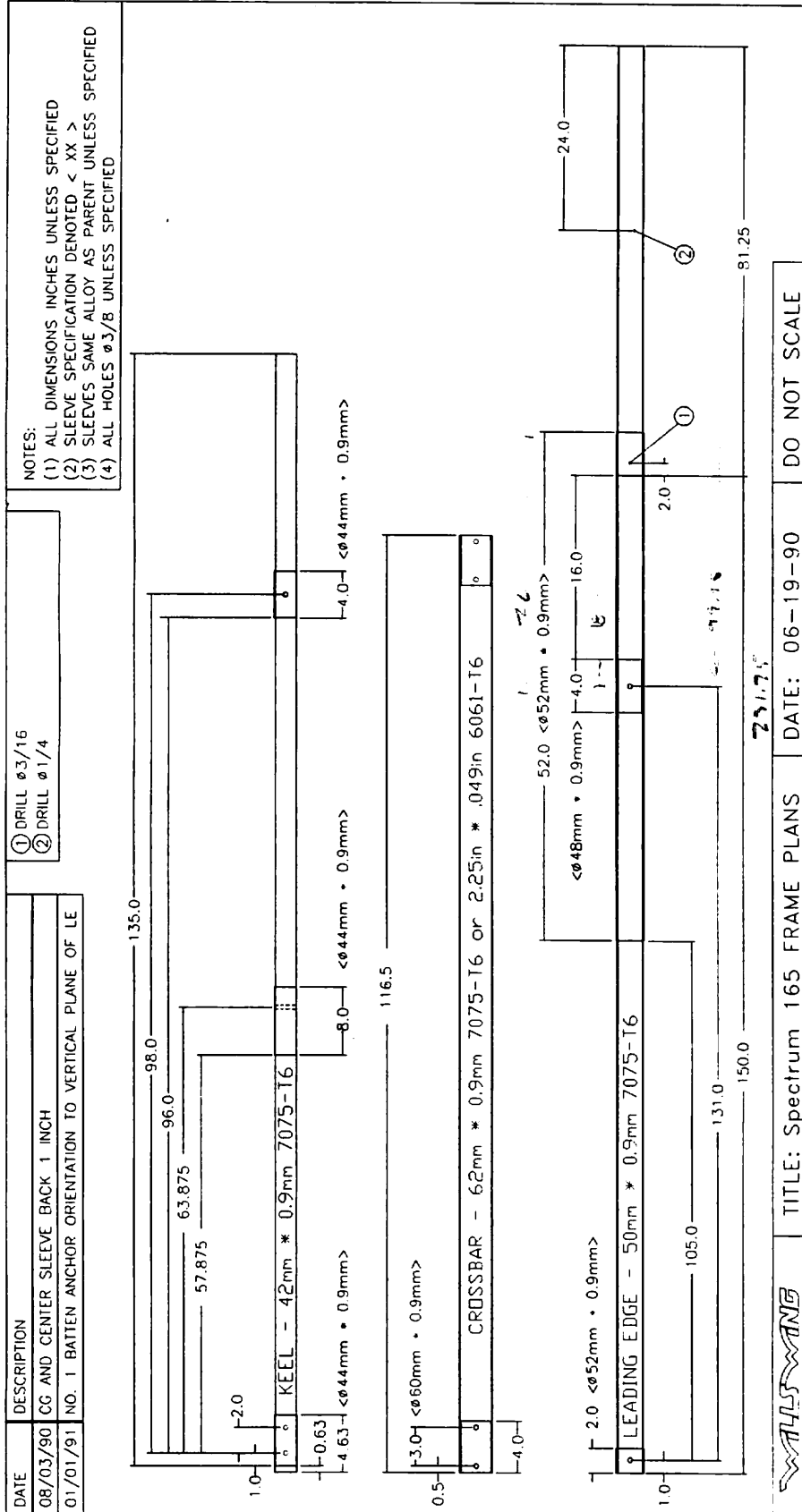

WALS WANE

TITLE: Spectrum 165 FRAME PLANS

DATE: 06-19-90

DO NOT SCALE

AT STYLE CONTROL BAR SPECIFICATIONS - REV 2/20/91

PART NAME	SIZE	APPLICATION	DAL	MATERIAL SPEC	INNER SLEEVE SPEC
ROUND BASE TUBE	AT62	AT144/AT150	510	SD 6061-T6 112500*065t	NA
	AT65	AT150/AT167/AT165/AT145	535	SD 6061-T6 112500*065t	NA
	AT68	AT180/AT158	560	SD 6061-T6 112500*065t	NA
SPEEDBAR	AT62	AT144/AT150	510	SD 6061-T6 112500*065t	NA
	AT65	AT150/AT167/AT165/AT145	535	SD 6061-T6 112500*065t	NA
	AT68	AT180/AT158	560	SD 6061-T6 112500*065t	NA
ROUND LEG	AT62	AT144/AT150	620	SD 6061-T6 112500*065t	NA
	AT65	AT150/AT167/AT165	650	SD 6061-T6 112500*065t	NA
	AT68	AT180	680	SD 6061-T6 112500*065t	SD 6061-T6 099300*065t
STREAMLINE LEG	AT62	AT144/AT150	620	EP 6063-T6 1025*194*035t	NA
	AT65	AT150/AT167/AT165	650	EP 6063-T6 1025*194*035t	NA
	AT68	AT180	680	EP 6063-T6 1025*194*035t	EP 6063-T6 222000*1200t
VG LEG SPECIFY L1 OR R1	AT65	AT145	650	EP 6063-T6 1025*194*035t	EP 6063-T6 222000*1200t
	AT68	AT158	680	EP 6063-T6 1025*194*035t	EP 6063-T6 222000*1200t

SCALE LIST (COMMON) EXTRUDED PROFILE QUANTITIES (DIMENSIONS) STREAMLINE LEG (INNER) SPECIFIC (LEFT OR RIGHT) QUANTITIES (ALL LENGTHS)

